

# IHS/IHSa SERIES

Software version 1.0

**Easy Reference:**

Model name of the scale:	
Serial number of the unit:	
Software revision number (Displayed when power is first turned on):	
Date of Purchase:	
Name of the supplier and place:	

# 1.0 CONTENTS

P.N. 700660189, Revision D3, November 2017

<b>1.0</b>	<b>CONTENT</b>	<b>3</b>
<b>2.0</b>	<b>INTRODUCTION</b>	<b>4</b>
2.1	INTRODUCTION	4
2.2	TECHNICAL SPECIFICATION	5
2.3	SAFETY NOTICE	6
2.4	KEY DESCRIPTION (IHS/IHSa)	6
2.5	DISPLAY (IHS/IHSa)	7
<b>3.0</b>	<b>OPERATION</b>	<b>8</b>
3.1	SAFETY INSTRUCTION	8
3.2	BATTERY OPERATION	9
3.3	CHARGING BATTERY	9
3.4	BASIC OPERATION	10
3.5	REMOTE CONTROLLER	10
<b>4.0</b>	<b>CALIBRATION</b>	<b>11</b>
<b>5.0</b>	<b>PARAMETER</b>	<b>11</b>
5.1	ENTER SETTING MODE	11
5.2	PARAMETER SETTING TABLE	12

## **2.0 INTRODUCTION**

### **2.1 INTRODUCTION**

The **IHS/IHSa** Series is a range of heavy-duty crane scales used to weigh very large masses.

The main features include:

- Easy Operation & Rugged construction
- 30mm super big & bright red LED display with view angle.
- 360 degree rotary safety hook design, easy to use
- Hold feature
- Overload safety up to 125%
- One charge can last 150 hours
- Auto power off after 30 minutes of non use
- 7.2Vdc 2 amp battery charger
- Aluminum die-casting housing
- Large remote control handset

## 2.2 TECHNICAL SPECIFICATIONS

Model No	Capacity	Division	Model No.	Capacity	Division
IHS 1	1000kg	0.2kg/0.5kg	IHS 2a	2000lb/1000kg	0.5lb/0.2kg
IHS 3	3000kg	0.5kg/1kg	IHS 6a	6000lb/3000kg	1lb/0.5kg
IHS 5	5000kg	1kg/2kg	IHS 10a	10000lb/5000kg	2lb/1kg
IHS 10	10000kg	2kg/5kg	IHS 20a	20000lb/10000kg	5lb/2kg

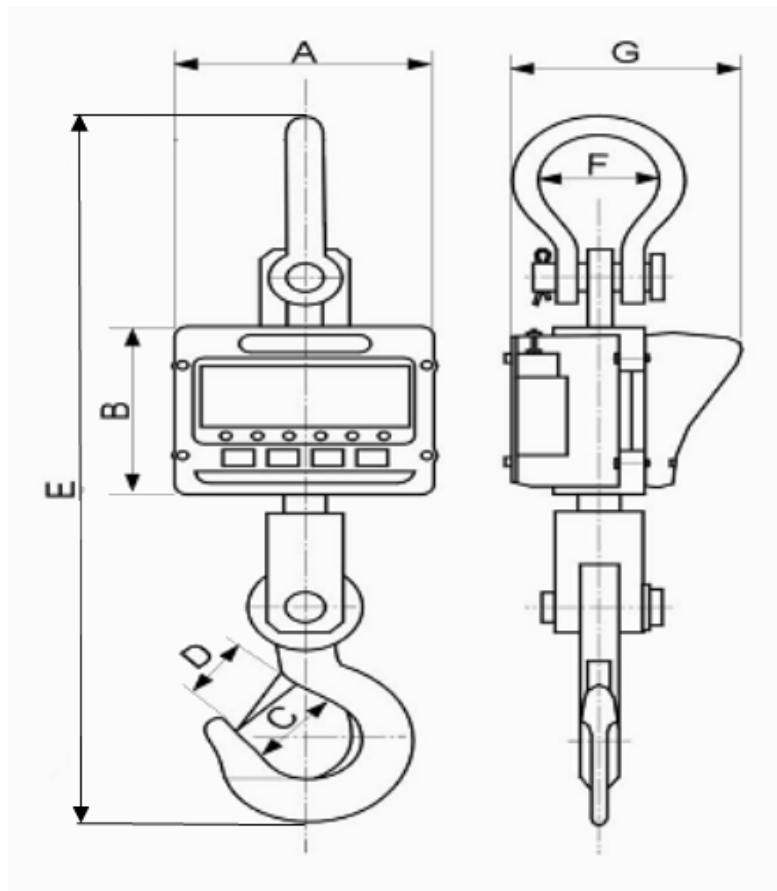

Model	A	B	C	D	E	F	G	Weight
IHS 1/2a	260	203	47	30	628	76	214	12kg
IHS 3/6a	260	203	47	30	628	76	214	14kg
IHS 5/10a	260	203	60	40	723	80	214	19kg
HIS 10/20a	260	203	70	50	837	90	214	31kg

### 2.3 SAFETY NOTICE

The limit stated below is the Ultimate Overload Limits of the scales.

Adam Equipment Co. Ltd. Its directors, owners and affiliated companies and organisations cannot be held liable for any resulting damage or injury sustained as a result of the machines being used in excess of their stated capacities or ultimate overload limits.

Model NO.	IHS 1/IHS 2a	IHS 3/IHS 6a	IHS 5/IHS 10a	IHS 10/IHS 20a
Max capacity	1000kg/2000lb	3000kg/6000lb	5000kg/10000lb	10000kg/20000lb
Overload capacity	1250kg/2500lb	3750kg/7500lb	6250kg/1250lb	12500kg/25000lb

#### NOTICE:

Do not use the scales if any parts are bent or loose or show signs of damage or wear. Refer to the user manual.

### 2.4 KEY DESCRIPTION IHS VERSION

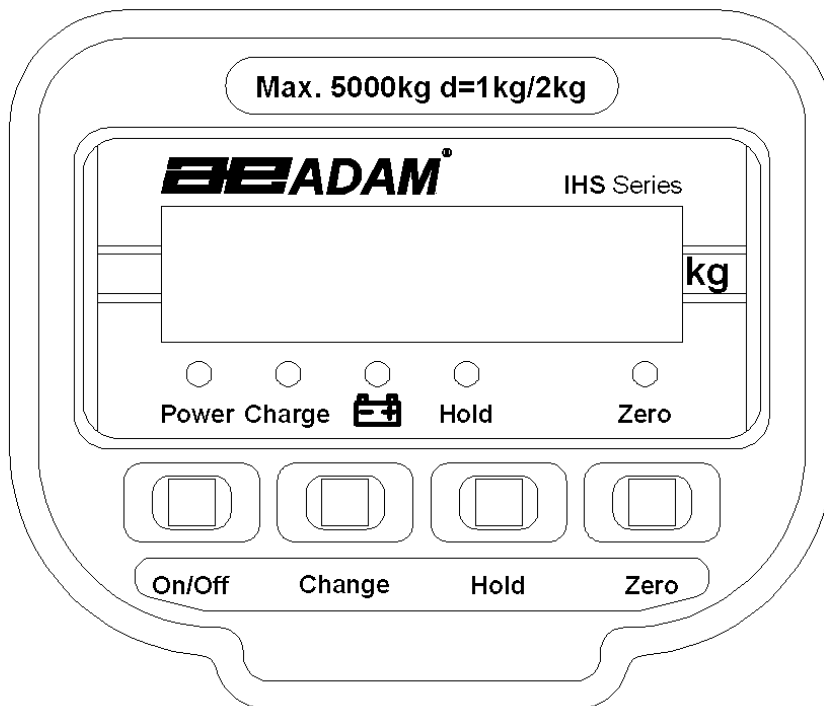

<b>[On/Off]</b>	Power switch- use this key to turn on and turn off the scale.
<b>[Change]</b>	Division change key- use this key to change division. When in setting mode, use this key to change parameter.
<b>[Hold]</b>	Hold function; use this key to lock the display. There is a LED indication light on the bottom of the display. Press the <b>[Hold]</b> key again, to cancel HOLD function.
<b>[Zero]</b>	Re-zero key- use this key to return to zero reading.

## 2.5 DISPLAY

<b>Power</b>	Power on mode
<b>Charge</b>	Charging mode
	Low battery
<b>Hold</b>	Hold mode
<b>Zero</b>	Zero indicator

## 2.4 KEY DESCRIPTION IHSa VERSION

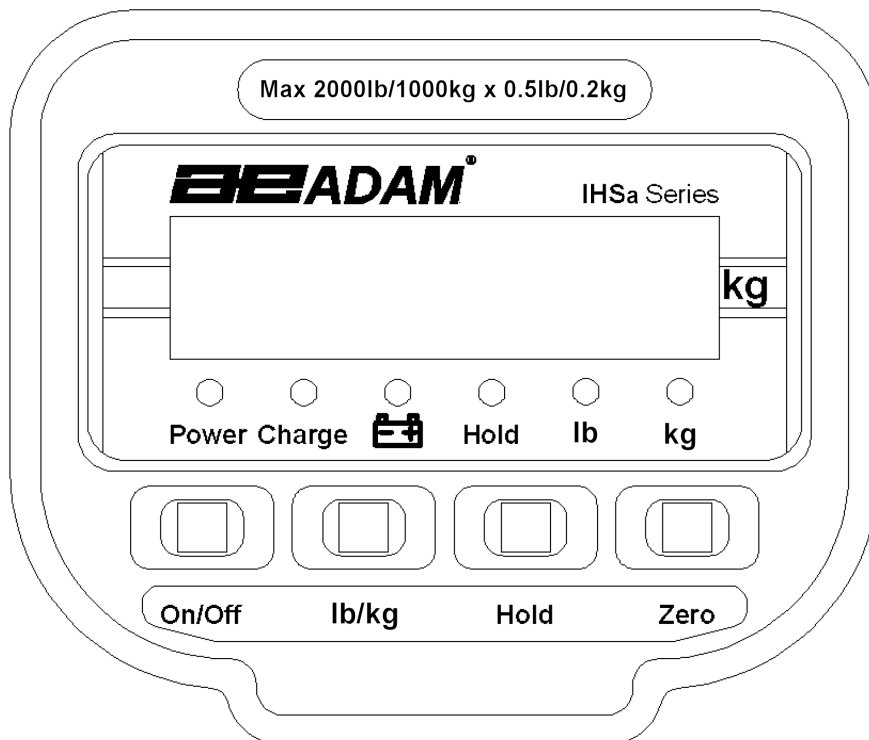

<b>[On/Off]</b>	Power switch- use this key to turn on and turn off the scale.
<b>[lb/kg]</b>	Unit change key-use this key to select the weighing unit of lb or kg. When in setting mode, use this key to change parameter.
<b>[Hold]</b>	Hold function, use this key to lock the display. There is a LED indication light on the bottom of the display. Press the <b>[Hold]</b> key again, to cancel HOLD function.
<b>[Zero]</b>	Re-zero key- use this key to return to zero reading.

## 2.5 DISPLAY

<b>Zero</b>	Zero indicator
<b>Charge</b>	Charging mode
	Low battery
<b>Hold</b>	Hold mode
<b>lb</b>	LB weighing mode
<b>kg</b>	KG weighing mode

## 3.0 OPERATION

### 3.1 SAFETY INSTRUCTIONS

Read this manual carefully before you operate the IHS Crane Scale.

- Unpack the Crane Scale carefully from the packing.
- Attach it to your hoist or equivalent existing equipment securely at the ground level, in the upright position. Make sure that the equipment to which the scale is attached is in proper condition. The operator should be trained for its safe operation.
- Carry out regular visual inspection for any damage or wear and tear on parts. Particularly the split pins at the hook and eyebolts and the inner wall of the hook and all joints should be checked regularly. If any damage or wear has taken place, replace the parts.



- Do all inspection and maintenance work when the scale is not in use.
- Do not expose the scale to extreme temperatures. The operating temperature range is 0° C to 40° C.
- Secure the sample to be weighed in the hook of the scale. Ensure that the sprung Safety Lever returns to its resting position which prevents the sample from slipping out of the hook.
- Do not exceed the maximum capacity of the Scale.
- Clean and protect your scale after use.

### **3.2 BATTERY OPERATION**

- The battery will operate continuously for 150 hours before requiring recharging. The scale will alert you when the battery is within 10 hours of requiring recharging by the indicator lamp above the low battery symbol to indicate that the battery is low voltage.
- When the battery requires charging, the scale will turn off to prevent battery damage. If the button is depressed at this point, the indicator lamp will reappear and then the scale will again deactivate automatically.
- Charging time for a completely discharged battery is approximately 16 hours. A full battery pack is recommended to keep the scale continuously operational.
- The scale will automatically power down after 30 minutes of non use to further protect the battery.

**Note:** More frequent charging of the battery prolongs its life.

### **3.3 CHARGING BATTERY**

- Plug the power supply into the mains power, then into the back of the IHS scale.
- The red indicator lamp will illuminate to indicate that the battery charger is functioning properly.
- The green indicator lamp will illuminate to indicate that the battery fully charged.

### 3.4 BASIC OPERATIONS

Power on and off- Press **[On/Off]** key to turn on the scale. Then the display on the scale will show **1888881**. Press again to turn off the scale.

Zero the scale-Depress the **[Zero]** to re-zero the reading.

Change division- you can use the **[Change/lb/kg]** key to change division.

Lb/kg- you use this to select either lb or kg weighing units

Hold -when required, such as when the reading is not stable or you cannot pause to record a reading, you can use the **[Hold]** key to lock the reading, so that you can read it easily later, after you finish reading, press **[Hold]** again to return to normal weighing mode.

**Note:** The **[Hold]** key has no affect if the Hold parameter has been disabled. See section 5.1

Overload Warning:- please do not add any item that exceeds the maximum capacity of the scale. When the buzzer is sounded and the display shows "----", remove the item to avoid damage to the load cell and scale.

### 3.5 REMOTE CONTROLLER

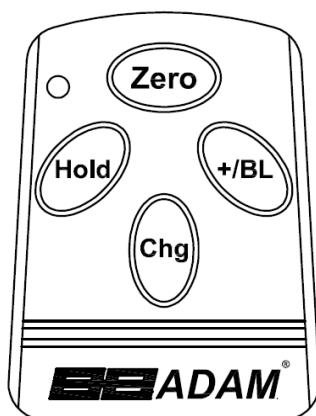

A: Determine increments in which the weight display

B: Hold the settled values

C: Zero the scale

D: Backlight (only used on scales with LCD display)

## 4.0 CALIBRATION

- Hold **[Zero]** when the scale is powered on.
- The display on the scale will show "SPAN". Make sure the hook is empty or has the slings or chains to be used in place. See Below.
- Depress the **[Zero]** button, the display on the scale will show "Set" then "0" and then "0000.0" after few seconds. Zero calibration is now complete.
- Enter the weight to calibrate with by using **[Hold]** key to increment a digit then the **[Change/lb/kg]** key to move it across the screen left.
- For example, the display on the IHS will display "3000.0" for a 3 ton calibration mass.
- Add the calibrated mass on the hook, it the best that the mass is close to the capacity where possible.
- When the scale is stable, press the **[Zero]**. The display shows 'HOLD'.
- After a few seconds, the calibration is complete.

\*\* To calibrate in pounds (lb) make sure that the scale is lb mode before commencing, to calibrate in kilograms (kg) make sure the scale is in kg mode before commencing.

When using slings, chains or other material to support the calibration mass, these items should be hung from the scale before setting the zero point so that when the calibration mass is added, only the weight of the calibration mass is measured by the scale.

If an error is detected when calibrating an error message will be shown.

Err 3 is when wrong data is entered for the mass, i.e. too small or wrong division.

Err-5 means the calibration has failed.

## 5.0 PARAMETER

### 5.1 ENTER SETTING MODE

Turn off the power of the scale and then turn the power on again.

Press the **[Change/lb/kg]** key during self-checking, display shows "**Bee0**", indicating the scale has entered the setting mode, press the **[Hold]** or **[Change/lb/kg]** key to shift the parameter items. Use **[Zero]** key confirm and escape from setting the current item.

## 5.2 PARAMETER SETTING TABLE

FUNCTION	DESCRIPTION	DEFAULT
<b>bEE</b>	Sets buzzer 0: Disable 1: Enable	<b>0</b>
<b>Hod</b>	Sets hold function 0: Disable 1: Enable	<b>0</b>
<b>Stb</b>	Sets zero function STb0: zeroing allowed when unstable STb1: zeroing not allowed when unstable	<b>0</b>
<b>Aut</b>	Sets auto backlight: (Only applies when the scale has an LCD display) <b>AUTO</b> : manual <b>AUT1</b> : auto	<b>0</b>
<b>CHt</b>	Sets units 0: lb 1: kg	<b>1</b>
<b>YES</b>	Sets save: 0: not saved 1: save	<b>0</b>



ADAM EQUIPMENT, MAIDSTONE ROAD, KINGSTON,  
MILTON KEYNES, MK10 0BD, U.K.  
Tel: +44 1908 274545 Fax: +44 1908 641339  
E-Mail Address: info@adamequipment.co.uk

## CRANE SCALES SAFE-LOAD STATEMENT

We hereby state that our Crane Scales are tested and inspected prior to dispatch. The safe-loads for the crane scales are listed below:

Model no	Max. capacity	Max ultimate overload limit
LHS 500 / LHS 1000a	500 kg / 1000 lb	625 kg / 1250 lb
LHS 1500 / LHS 3000a	1500 kg / 3000 lb	1875 kg / 3750 lb
LHS 2000 / LHS 4000a	2000 kg / 4000 lb	2500 kg / 5000 lb
SHS 50 / SHS 100a	50 kg / 100 lb	62.5 kg / 125 lb
SHS 150 / SHS 300a	150 kg / 300 lb	187.5 kg / 375 lb
SHS 300 / SHS 600a	300 kg / 600 lb	375 kg / 750 lb
IHS 1 / IHS 2a	1000 kg / 2000 lb	1250 kg / 2500 lb
IHS 3 / IHS 6a	3000 kg / 6000 lb	3750 kg / 7500 lb
IHS 5 / IHS 10a	5000 kg / 10000 lb	6250 kg / 12500 lb
IHS 10 / IHS 20a	10000 kg / 20000 lb	12500 kg / 25000 lb

The limits stated above are the ultimate overload limits of the scales. Adam Equipment Co. Ltd. its directors, owners and affiliated companies and organizations cannot be held liable for any resulting damage or injury sustained as a result of the machines being used in excess of their stated maximum capacity, capabilities and ultimate overload limits. To avoid possible injury or death, read all instructions stated in the Manual before using.

## **WARRANTY STATEMENT**

Adam Equipment offers Limited Warranty (Parts and Labour) for any components that fail due to defects in materials or workmanship. Warranty starts from the date of delivery.

During the warranty period, should any repairs be necessary, the purchaser must inform its supplier or Adam Equipment Company. The company or its authorised Technician reserves the right to repair or replace the components at any of its workshops at no additional cost, depending on the severity of the problems. However, any freight involved in sending the faulty units or parts to the Service Centre should be borne by the purchaser.

The warranty will cease to operate if the equipment is not returned in the original packaging and with correct documentation for a claim to be processed. All claims are at the sole discretion of Adam Equipment.

This warranty does not cover equipment where defects or poor performance is due to misuse, accidental damage, exposure to radioactive or corrosive materials, negligence, faulty installation, unauthorised modifications or attempted repair, or failure to observe the requirements and recommendations as given in this User Manual.

This product may include a rechargeable battery that is designed to be removed and replaced by the user. Adam Equipment warrants that it will provide a replacement battery if the battery manifests a defect in materials or workmanship during the initial period of use of the product in which the battery is installed.

As with all batteries, the maximum capacity of any battery included in the product will decrease with time or use, and battery cycle life will vary depending on product model, configuration, features, use, and power management settings. A decrease in maximum battery capacity or battery cycle life is not a defect in materials or workmanship, and is not covered by this Limited Warranty.

Repairs carried out under the warranty do not extend the warranty period. Components removed during warranty repairs become company property.

The statutory rights of the purchaser are not affected by this warranty. The terms of this warranty is governed by the UK law. For complete details on Warranty Information, see the terms and conditions of sale available on our web-site.

## WEEE 2012/19/EU

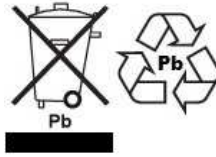

This device may not be disposed of in domestic waste. This also applies to countries outside the EU, per their specific requirements. Disposal of batteries (if fitted) must conform to local laws and restrictions.  
Cet appareil ne peut être éliminé avec les déchets ménagers. L'élimination de la batterie doit être effectuée conformément aux lois et restrictions locales.  
Dieses Gerät nicht mit dem Hausmüll entsorgt.  
Dispositivo no puede ser desechado junto con los residuos domésticos  
Dispositivo non può essere smaltito nei rifiuti domestici.

### FCC / IC CLASS A DIGITAL DEVICE EMC VERIFICATION STATEMENT

NOTE: This equipment has been tested and found to comply with the limits for a Class A digital device, pursuant to Part 15 of the FCC rules and Canadian ICES-003/NMB-003 regulation. These limits are designed to provide reasonable protection against harmful interference when the equipment is operated in a commercial environment. This equipment generates, uses and can radiate radio frequency energy and, if not installed and used in accordance with the instruction manual, may cause harmful interference to radio communications. Operation of this equipment in a residential area is likely to cause harmful interference in which case the user will be required to correct the interference at his own expense.

### CALIFORNIA PROPOSITION 65 - MANDATORY STATEMENT

WARNING: This product includes a sealed lead-acid battery which contains chemicals known to the State of California to cause cancer and birth defects or other reproductive harm.



Adam Equipment products have been tested with, and are always supplied with mains power adaptors which meet all legal requirements for the intended country or region of operation, including electrical safety, interference and energy efficiency. As we often update adaptor products to meet changing legislation it is not possible to refer to the exact model in this manual. Please contact us if you need specifications or safety information for your particular item. Do not attempt to connect or use an adaptor not supplied by us.

**ADAM EQUIPMENT** is an ISO 9001:2008 certified global company with more than 40 years' experience in the production and sale of electronic weighing equipment.

Adam products are predominantly designed for the Laboratory, Educational, Health and Fitness, Retail and Industrial Segments. The product range can be described as follows:

- Analytical and Precision Laboratory Balances
- Compact and Portable Balances
- High Capacity Balances
- Moisture analysers / balances
- Mechanical Scales
- Counting Scales
- Digital Weighing/Check-weighing Scales
- High performance Platform Scales
- Crane scales
- Mechanical and Digital Electronic Health and Fitness Scales
- Retail Scales for Price computing

For a complete listing of all Adam products visit our website at  
[www.adamequipment.com](http://www.adamequipment.com)

<p><b>Adam Equipment Co. Ltd.</b>  Maidstone Road, Kingston  Milton Keynes  MK10 0BD  UK  Phone:+44 (0)1908 274545  Fax: +44 (0)1908 641339  e-mail: <a href="mailto:sales@adamequipment.co.uk">sales@adamequipment.co.uk</a></p>	<p><b>Adam Equipment Inc.</b>  1, Fox Hollow Rd.,  Oxford CT  06478  USA  Phone: +1 203 790 4774  Fax: +1 203 792 3406  e-mail: <a href="mailto:sales@adamequipment.com">sales@adamequipment.com</a></p>	<p><b>AE Adam GmbH.</b>  Instenkamp 4  D-24242 Felde   Germany  Phone +49 (0)4340 40300 0  Fax: +49 (0)4340 40300 20  e-mail:  <a href="mailto:vertrieb@aeadam.de">vertrieb@aeadam.de</a></p>
<p><b>Adam Equipment S.A. (Pty) Ltd.</b>  7 Megawatt Road,  Spartan EXT 22  Kempton Park,  Johannesburg,  Republic of South Africa   Phone +27 (0)11 974 9745  Fax: +27 (0)11 392 2587  e-mail: <a href="mailto:sales@adamequipment.co.za">sales@adamequipment.co.za</a></p>	<p><b>Adam Equipment (S.E. ASIA) PTY Ltd</b>  2/71 Tacoma Circuit  CANNING VALE 6155  Perth  Western Australia   Phone: +61 (0) 8 6461 6236  Fax +61 (0) 8 9456 4462  e-mail: <a href="mailto:sales@adamequipment.com.au">sales@adamequipment.com.au</a></p>	<p><b>Adam Equipment (Wuhan) Co. Ltd.</b>  A Building East Jianhua  Private Industrial Park  Zhuanyang Avenue  Wuhan Economic &amp; Technological  Development Zone  430056 Wuhan  P.R.China  Phone: + 86 (27) 59420391  Fax + 86 (27) 59420388  e-mail:  <a href="mailto:info@adamequipment.com.cn">info@adamequipment.com.cn</a></p>

© Copyright by Adam Equipment Co. All rights reserved. No part of this publication may be reprinted or translated in any form or by any means without the prior permission of Adam Equipment.

Adam Equipment reserves the right to make changes to the technology, features, specifications and design of the equipment without notice.

All information contained within this publication is to the best of our knowledge timely, complete and accurate when issued. However, we are not responsible for misinterpretations which may result from the reading of this material.

The latest version of this publication can be found on our Website.

[www.adamequipment.com](http://www.adamequipment.com)