

# CBD SERIES

Software revision 3.26

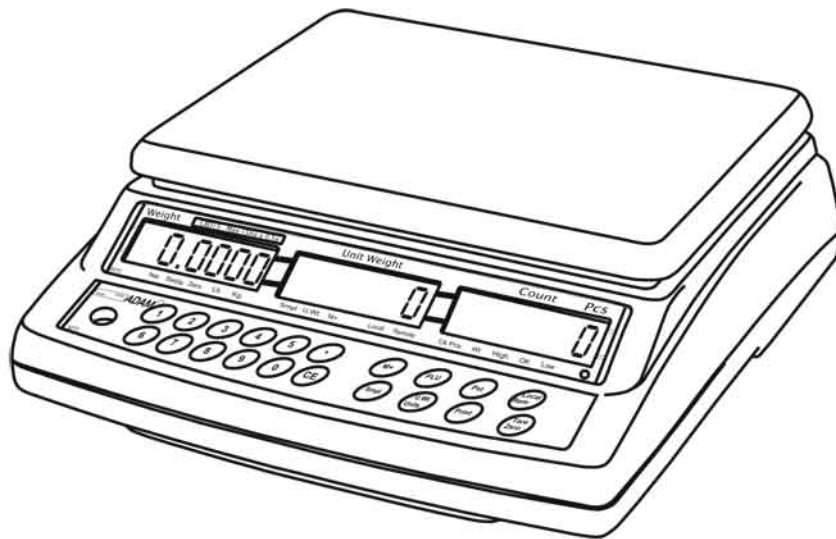

**Easy Reference:**

Model name of the scale:	
Serial number of the unit:	
Software revision number (Displayed when power is first turned on):	
Date of Purchase:	
Name of the supplier and place:	

# 1.0 CONTENT

P.N. 302666242, Revision B1, November 2016

1.0	<b>CONTENT</b>	3
2.0	<b>INTRODUCTION</b>	4
3.0	<b>TECHNICAL SPECIFICATION</b>	5
3.1	SPECIFICATIONS FOR THE LOCAL SCALE	5
3.2	SPECIFICATIONS FOR THE REMOTE SCALE	5
3.3	COMMON SPECIFICATIONS	5
4.0	<b>INSTALLATION</b>	6
4.1	LOCATING THE SCALES	6
4.2	SETTING UP THE SCALES	7
4.3	REMOTE SCALE SET UP	8
5.0	<b>KEY DESCRIPTIONS</b>	9
6.0	<b>DISPLAYS</b>	10
6.1	WEIGHT WINDOW	10
6.2	UNIT WEIGHT WINDOW	10
6.3	COUNT WINDOW	11
7.0	<b>OPERATION</b>	11
7.1	ZEROING AND TARING THE DISPLAY	12
7.2	MEMORY FUNCTIONS	13
7.2.1	MANUAL ACCUMULATION	13
7.2.2	AUTOMATIC ACCUMULATED TOTAL	14
7.3	PARTS COUNTING	14
7.3.1	WEIGHING A SAMPLE TO DETERMINE THE UNIT WEIGHT	14
7.3.2	ENTERING A KNOWN UNIT WEIGHT	15
7.3.3	AUTOMATIC UPDATE OF UNIT WEIGHT	15
7.3.4	COUNT PRE-SET OR CHECK-WEIGHING	15
7.4	PLU (Product Look Up)	17
7.4.1	STORING PLU'S MANUALLY	17
7.4.2	ENTERING DESCRIPTION MANUALLY	19
7.4.3	RECALLING PLU'S MANUALLY	20
8.0	<b>PARAMETERS</b>	21
8.1	REAL TIME CLOCK	23
9.0	<b>BATTERY OPERATION</b>	24
10.0	<b>RS-232 OUTPUT</b>	25
10.1	INPUT COMMANDS FORMAT	26
10.2	STORING DATA VIA RS232	27
10.3	PLU ENTRY USING RS-232 INTERFACE	27
11.0	<b>CALIBRATION</b>	28
12.0	<b>ERROR CODES</b>	30
13.0	<b>TECHNICAL PARAMETERS</b>	31
14.0	<b>REPLACEMENT PARTS AND ACCESSORIES</b>	33
15.0	<b>SERVICE INFORMATION</b>	33

## 2.0 INTRODUCTION

- The CBD series offers a range of an accurate, fast and versatile counting scales that can use one additional external platform (Remote scale) for weighing or counting of heavier items.
- These counting scales have the ability to use many stored information (PLU).
- The scale can be operated using either pounds only, kilograms only or can be switched between pounds and kilograms.
- All have stainless steel weighing platform on a Steel base assembly.
- All the keypads are sealed, colour coded membrane switches and the displays are large easy to read liquid crystal type displays (LCD). The LCD's are supplied with a backlight.
- All units include automatic zero tracking, audible alarm for pre-set weights, automatic tare, pre-set tare and an accumulation facility that allows the count to be stored and recalled as accumulated total.
- The scales have an bi-directional RS-232 interface for communicating with a PC or printer. An optional USB interface is available.

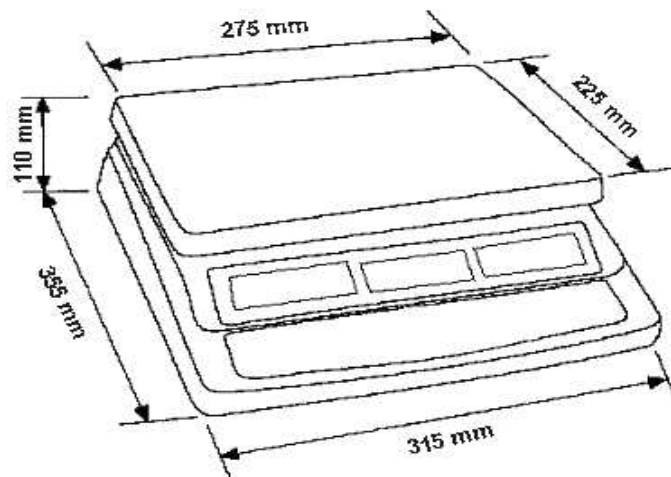

### 3.0 TECHNICAL SPECIFICATION

#### 3.1 SPECIFICATIONS FOR THE LOCAL SCALE

Model #	CBD 4 CBD 8a	CBD 8 CBD 16a	CBD 16 CBD 35a	CBD 32 CBD 70a	CBD 48 CBD 100a
Maximum Capacity	4 kg / 8 lb	8 kg / 16 lb	16 kg / 35 lb	32 kg / 70 lb	48 kg / 100 lb
Readability	0.0001 kg / 0.0002 lb	0.0002 kg / 0.0005 lb	0.0005 kg / 0.001 lb	0.001 kg / 0.002 lb	0.002 kg / 0.005 lb
Tare Range	-4 kg / -8lb	-8 kg / -9.9995 lb	-9.9995 kg / -35 lb	-32 kg / -70 lb	-48 kg / -99.995 lb
Repeatability (Std Dev)	0.0001 kg / 0.0002 lb	0.0002 kg / 0.0005 lb	0.0005 kg / 0.001 lb	0.001 kg / 0.002 lb	0.002kg / 0.005 lb
Linearity ±	0.0002 kg / 0.0005 lb	0.0004 kg / 0.001 lb	0.001 kg / 0.002 lb	0.002 kg / 0.004 lb	0.004 kg / 0.01 lb
Units of Measure	kg, lb				

#### 3.2 SPECIFICATIONS FOR THE REMOTE SCALE

Excitation voltage	5 VDC
Signal range	0-20 mV (allows 3 mV/ V LC with 5 mV zero offset)
Zero range	0-5 mV
Sensitivity	0.02µV / internal ADC count or better
Internal ADC counts	500,000 typical at 10 mV input
Load	87 ohm – 1200 ohm, Suitable for 4 X 350 ohm load cells
Connection	4 wire connection to load cells plus shield
Maximum cable length	6 meters
Termination	9 pin D-subminiature plug on scale



#### 3.3 COMMON SPECIFICATIONS

Interface	Bi-directional RS-232 Interface Optional USB Serial Interface
Stabilisation Time	2 Seconds
Operating Temperature	0°C - 40°C
Power supply	115/230 VAC 50/60Hz. or 12 VDC 800 mA from external power supply for USA
Calibration	Automatic external
Display	3 x 6 digits LCD digital display
Housing	Indicator ABS Plastic, Stainless Steel platform

Pan size	225 x 275mm 8.9" x 10.8"
Overall dimensions	315 x 355 x 110mm 12.4" x 14" x 4.3"
Net weight	4.4 kg / 9.7 lb
Applications	Counting Scale
Functions	Weighing, parts counting, accumulating memory, preset count with alarm, up to 100 PLUs with description, unit & tare weight
Other Features and Specs	Accuracy enhancement for parts counting, internal rechargeable battery (up to 70 hours operation dependent on number of load cells used and use of the backlight)

## 4.0 INSTALLATION

### 4.1 LOCATING THE SCALES

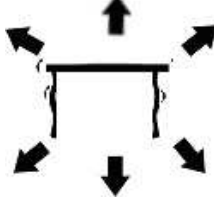
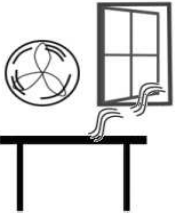
	<ul style="list-style-type: none"> <li>• The scales should not be placed in a location that will reduce the accuracy.</li> <li>• Avoid extremes of temperature. Do not place in direct sunlight or near air conditioning vents.</li> <li>• Avoid unsuitable tables. The table or floor must be rigid and not vibrate.</li> <li>• Avoid unstable power sources. Do not use near large users of electricity such as welding equipment or large motors.</li> <li>• Do not place near vibrating machinery.</li> <li>• Avoid high humidity that might cause condensation. Avoid direct contact with water. Do not spray or immerse the scales in water.</li> <li>• Avoid air movement such as from fans or opening doors. Do not place near open windows or air-conditioning vents.</li> <li>• Keep the scales clean. Do not stack material on the scales when they are not in use.</li> </ul>
	
	
	

## 4.2 SETTING UP THE SCALES

### SETTING UP THE LOCAL SCALE

- The CBD Series comes with a stainless steel platform packed separately.
- Place the platform in the locating holes on the top cover.
- Do not press with excessive force as this could damage the load cell inside.
- Level the scale by adjusting the four feet. The scale should be adjusted such that the bubble in the spirit level is in the centre of the level and the scale is supported by all four feet.

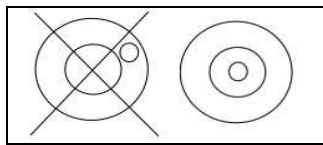

- AC powered scales, attach the power cable to the connector on the bottom of the scale base. If using the external plug in power supply module (USA) connect it to the socket on the side.
- The power switch is located at the right side of the scale base.
- The scale will show the model number in the “**Weight**” display window (CBD 15, where 15 denotes the maximum capacity of the scale in Kg) and the current software revision number in the “**Unit Weight**” display window.
- Next a self-test is followed. At the end of the self-test, it will display “zero weight and zero values in all three displays. If the weight display shows a value it was not possible to set a new zero during power on.

### SETTING UP THE REMOTE SCALE

- The CBD Series can be connected to any size of load cell type weighing base via the Remote scale port on the right side of the scale case. Ensure you have the correct base for the scale as each is matched for calibration.
- Place the remote scale platform in the position where it is to be used. Level the scale by adjusting the four feet. If fitted with a spirit level then it should be adjusted such that the bubble is in the centre.
- Press [**Local/Rem**] to select the local scale or the remote base for configuration and operation.

## **REMOTE SCALE CONNECTION**

The cable for the load cell goes to a 9 pin D-subminiature plug connector with the following connections:

<b>Pin numbers</b>	<b>Connection</b>
Pins 1,2	- Excitation (0 V)
Pins 4,5	+ Excitation (+5 V)
Pin 7	+ Signal
Pin 8	- Signal

(The sense wires connections of a six wire load cell are not used and should be connected to the respective Excitation pins).

### **4.3 REMOTE SCALE SET UP**

The remote scale should be set for a realistic resolution with respect to the input provided by the load cell/s. See Section 13 for details of configuring the remote scale.

If a single 2 mV / V load cell is fitted and more than 60% of the load cell is used for full capacity then the high output of >6 mV span makes it possible to set a high resolution.

If this criterion is met then the remote scale can be set to a high resolution with a maximum of 1:30,000, i.e. 300 kg x 0.01 kg.

Where more than one load cell is fitted or the total load cell capacity is not utilised then a reduced resolution should be selected in the remote scale technical set up. For example, if a system uses four 2 mV / V 1000 kg load cells for a scale of 1000 kg capacity then the span output at full scale will be only 2.5 mV.

In this situation the resolution should be reduced to give a good number of ADC counts per displayed division. i.e. Set to 1:5000 or 1000 kg x 0.2 kg.

Setting a high resolution without providing a good input to the remote scale ADC will not give better accuracy and may make the scale difficult to meet performance specification.

For best performance ensure a minimum of 0.222V / d.



## 5.0 KEY DESCRIPTIONS

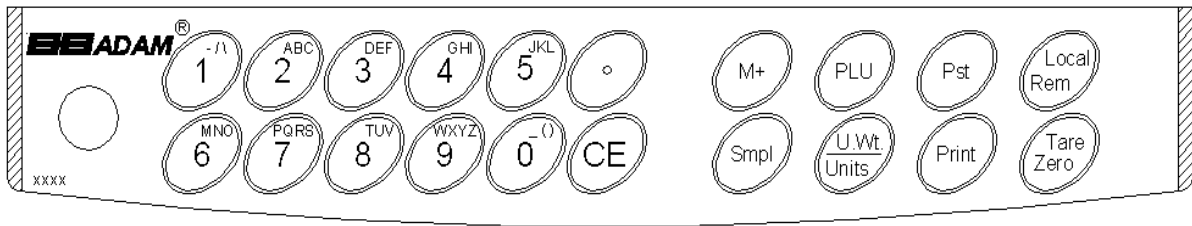

### [0-9, •]

These keys are used to manually enter a value for tare weights, unit weight and sample size. A secondary function is to enter alpha-numeric characters for PLU descriptions etc.

### [CE]

Pressing this key clears the unit weight or an erroneous entry. It also clears the memory accumulation when the total is displayed.

### [M+]

This key is used to add the current count to the accumulator. It also recalls the memory when pressed with no load on the scale. Up to 99 values or full capacity of the weight display can be added. Also prints the displayed values when Auto print is switched off.

### [Smpl]

This is used to enter the number of items of a sample.

### [PLU]

To store and recall the Product Look Up sample information.

### [U. Wt./Units]

This key is used to enter the weight of a sample manually. It will also change the weighing units when other units are enabled.

### [PST]

To set the upper limit for the number of items counted. When this upper limit is exceeded the scale will sound the beeper. A secondary function is to use it access the menus for user settings.

### [Print]

It is used to print the weighing data.

### [Local Rem]

This key is used to select the local or remote scale.

### [Tare/Zero]

This key has a combined Zero and Tare function.

If the net weight is below  $\pm 2\%$  of maximum then it acts as a Zero key. This sets the zero point for all subsequent weighing by setting the display to zero.

It also tares the scale by storing the current weight in the memory as a tare value, subtracting the tare value from the total weight and displaying the results as a net weight.

## 6.0 DISPLAYS

The scales have three display windows- **Weight**, **Unit Weight** and **Count**.

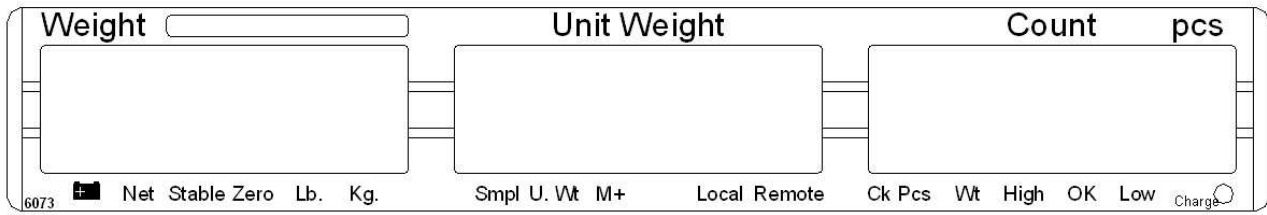

### 6.1 WEIGHT WINDOW

This consists of a 6 digit display to indicate the weight on the scale.

An arrow above the symbols will indicate the following:

Low battery, 
Net Weight Display, " <b>Net</b> "
Stability indicator, " <b>Stable</b> "
Zero indicator, " <b>Zero</b> "
Unit in use indicator, " <b>Lb</b> " or " <b>Kg</b> "

### 6.2 UNIT WEIGHT WINDOW

This display will show the unit weight of a sample. This value is either entered by the user manually or computed by the scale. The unit of measure is either gram on all scales with kilogram selected as weighing unit or in pounds.

When the scale has determined that there is insufficient number of samples to accurately determine the count, an arrow will be shown above "**Smpl**".

When the unit weight is not large enough to determine an accurate count, the arrow will show at "**U.Wt**".

When a value has been entered into the memory, the arrow above "**M+**" will be on.

In both the cases the scale continues to operate and the indicators are to alert the user of a potential problem.

### 6.3 COUNT WINDOW

This display will show the number of items on the scale or the value of the accumulated count. See the OPERATION section.

An arrow above the symbols will indicate the following:

- Checkweighing is active during counting, "Ck Pcs"
- Checkweighing is active during weighing, "Ck Wt"
- Checkweighing is active, result is above the High Limit, "High"
- Checkweighing is active, result is between the Low and High Limit, "OK"
- Checkweighing is active, result is below the Low Limit, "Low"

Just under the "Count" display is an LED to indicate the status of the battery charging. When the scale is plugged into the main power the internal battery will be charged. If the LED is green, the battery has a full charge. If it is red, the battery requires further charging and yellow indicates the battery is being charged.

## 7.0 OPERATION

The basic weighing functions are same for both the local and remote scales. However the number of weighing divisions may be less on the remote scale dependant on the total capacity of the load cell/s used.

Each scale (local or remote) has the ability to count parts based on the current unit weight. This is best obtained by weighing and counting a sample on the local scale which may have the best sensitivity. Then the scale can be switched to the remote where large quantities can be counted.

Each scale has a separate tare value that can be entered through the keypad or by placing a weight on the platform and pressing the [Tare/Zero] key. The tare value for each scale is retained as the user switches between the remote and local scales.

Either scale can be used to determine a unit weight.

When the scale is switched from local to remote, a clear display will be shown to identify the change and the scales will count based on the tare and unit weight currently in use for the scale selected. Display for the change is:

**"c h A n g E" "L o c A L" and "c h A n g E" "r e m o t E"**

The display will be based on the 7 segment interpretations, some of the letters are shown later.

The switch from local scale to remote scale should be possible at any time by pressing the **[Local/Rem]** key.

**NOTE:** For frequently used items, counting is made easier by using PLU numbers (Product Look Up). Up to 100 PLU's can be stored and recalled. Place the item on the pan and enter the appropriate PLU number using the keypad. The scale will display the Total Weight, Unit weight and the Count of the item in the respective windows. See section 7.4.

## **7.1 ZEROING AND TARING THE DISPLAY**

The Tare and Zero function are combined into one key. When the gross weight is within  $\pm 2\%$  of the zero, set at power on for either scale then a new zero is set. If the gross weight is greater than  $\pm 2\%$  then the tare function is performed.

### **ZEROING**

You can press the **[Tare/Zero]** key at any time to set the zero point from which all other weighing and counting is measured. When the zero point is obtained the **Weight** display will show the indicator at "**Zero**".

The scale has an automatic re-zeroing function to account for minor drifting or accumulation of material on the platform. However you may need to press the **[Tare/Zero]** to re-zero the scale if small amounts of weight are still shown even when the platform is empty.

### **TARING**

Preset tare values can be used with both the local and remote scale. If a new tare value is to be used, there are two methods for entering a tare value. The first method uses the weight on the platform and the second uses a value to be entered by the user.

#### **FIRST METHOD OF ENTERING A TARE VALUE:**

- Zero the scale by pressing the **[Tare/Zero]** key, if necessary. The arrow indicator over "**Zero**" will be on.
- Place a container on the platform, a value for its weight will be displayed.
- Press the **[Tare/Zero]** key to tare the scale. The weight that was displayed is stored as the tare value and that value is subtracted from the display, leaving zero on the display. The arrow over "**Net**" will be on. As product is added only the net weight of the product will be shown. The scale could be tared a second time if another type of product was to be added to the first one. Again only the weight that is added after taring will be displayed.

- When the container is removed a negative value will be shown. If the scale was tared just before removing the container this value is the gross weight of the container plus all products those were removed. The zero indicator will also be ON because the platform is back to the same condition as it was when the **[Tare/Zero]** key was last pressed.

## **SECOND METHOD OF ENTERING A TARE VALUE:**

- This method allows you to enter a value for the tare weight from the keypad. This is useful if all containers are the same or if the container is already full but the net weight is required and the weight of the container is known.
- Remove all weights from the platform, press the **[Tare/Zero]** key to zero the display.
- Enter the value for the Tare weight including decimal point using the keypad, press **[Tare/Zero]** to store the tare value. The weight will show a negative value equal to the tare.
- Place the container on the platform.
- The display will then show the weight of the container minus the tare weight. When the full container is placed on the platform the tare value will be subtracted from the gross weight displaying only the net weight of the contents.
- If the value input is not consistent with the increment of the scale, the scale will round the tare value to the nearest value possible. For example, if a tare value of 103g is entered into the 60Kg scale with 5g readability, then the display will show -105g.
- The tare value for each scale is held in memory so that they are not lost when the active scale changes.

## **7.2 MEMORY FUNCTIONS**

The **[M+]** key will add the results of a weighing into memory, regardless of whether the local or remote scale is being used for the weighing.

### **7.2.1 Manual accumulation**

The values (weight and count) shown on the display can be added to the values in the accumulator by pressing the **[M+]** key. The "**Weight**" display will show the total weight, the "**Count**" display will show the total accumulated count and the "**Unit Weight**" display shows the number of times items have been added to the accumulation memory. The values will be displayed for 2 seconds before returning to normal.

The scale must return to zero or a negative number before another sample can be added to the memory.

More products can then be added and the **[M+]** key pressed again. This can continue for up to 99 entries or until the capacity of the "**Weight**" display is exceeded.

To observe the total value stored, press the **[M+]** key when the scale is at zero. The total will be displayed for 2 seconds.

To clear the memory, first press **[M+]** to recall the total from the memory and then press **[CE]** to clear all values from the memory.

### **7.2.2 Automatic accumulated total**

The scale can be set to automatically accumulate total when a weight is placed on the scale. This eliminates the need to press the **[M+]** key to store values into the memory. However the **[M+]** key is still active and can be pressed to store the values immediately. In this case, the values will not be stored when the scale returns to zero.

See Section 8 for enabling Automatic Accumulation.

## **7.3 PARTS COUNTING**

The basic function of parts counting is same for both the scales. In order to do parts counting it is necessary to know the average weight of the items to be counted. This can be done either by weighing a known number of the items and letting the scale determine the average unit weight or by manually inputting a known unit weight using the keypad.

Either of the scales can be used to determine the sample unit weight or for the manual entry which can be used to count using either of the scales.

It is possible to increase the accuracy of the unit weight at any time during the counting process by entering the count displayed and then pressing the **[Smpl]** key. You must ensure that the quantity displayed matches the quantity on the scale before pressing the key. The unit weight can be adjusted based on a larger sample quantity. This will give greater accuracy when counting larger sample sizes.

### **7.3.1 Weighing a sample to determine the Unit Weight**

To determine the average weight of the items to be counted place a known quantity of the items on the scale and then enter the quantity being weighed. The scale will then divide the total weight by the number of samples and display the average unit weight.

- Zero the scale by pressing the **[Zero]** key if necessary. If a container is to be used, place the container on the scale and tare as discussed earlier.
- Place a known quantity of items on the scale. After the “**Weight**” display is stable enter the quantity of items using the numeric keys followed by pressing the **[Smpl]** key. The number of units will be displayed on the “**Count**” display and the computed average weight will be shown on the “**Unit Weight**” display.
- As more items are added to the scale, the weight and the count will increase.
- If the scale is not stable, the calculation will not be completed.

- If the weight is below zero, the “**Count**” display will show negative count.

### **7.3.2 Entering a known Unit Weight**

If the unit weight is already known then it can be entered using the keypad.

Enter the value of the unit weight using the numeric keys followed by pressing the **[U. Wt.]** key within few seconds while the display is flashing. If no action is initiated within a few seconds, the “**Unit Weight**” display will revert to the previous value, otherwise it will show the new value that has been entered.

The sample is then added to the scale and the weight will be displayed as well as the quantity based upon the unit weight. When weighing in kilograms the unit weight is shown in grams. When weighing in pounds the unit weight is shown in pounds.

After the unit weight has been determined or entered, the scale can be used for parts counting. The scale may be tared to account for the net weight as discussed in an earlier section.

After the scale is tared, the items to be counted are added and the “**Count**” display will show the number of items computed using the weight and the unit weight.

It is possible to increase the accuracy of the unit weight at any time during the counting process by manually entering the sample quantity and then pressing the **[Smpl]** key. You must ensure that the quantity displayed matches the quantity on the scale before pressing the key. The unit weight will be adjusted based upon a larger sample quantity. This will give greater accuracy when counting larger sample sizes.

### **7.3.3 Automatic update of unit weight**

The scales will automatically update the unit weight when a sample less than the initial sample count is added. A beep will be heard when the value is updated. It is wise to check the quantity is correct when the unit weight has been updated automatically.

To lock the unit weight and prevent Auto-update, press **[U.Wt.]**.

This feature is turned off as soon as the number of items added exceeds the count used as a sample.

### **7.3.4 Count pre-set or check-weighing**

Check-weighing (or Count Pre-setting) is a procedure to cause an alarm to sound when the net weight (or the number of items) on the scale meets or exceeds a number stored in memory. The value to be stored is entered from the keyboard.

## **SETTING OF PRESET LIMITS**

It is possible to set a high and low limit for either counting or weighing (using net weight). When the **[Pst]** key is pressed the user can select either counting or weighing and then set the lower and upper limit.

For example:

ACTION	DISPLAYS
Press <b>[Pst]</b>	"CHECK " " nEt " " " if currently in the weighing mode
Press <b>[U.Wt/Units]</b>	"CHECK " " CoUnt " " " to toggle from weighing to counting
Press <b>[Print]</b>	"Hi cnt" "0.3 2 3 4" " " The current high count limit is displayed, press <b>[CE]</b> to clear and change if needed. If using net weight the display will show "Hi WEG"
Press <b>[Print]</b>	"lo cnt" "0.0 2 3 4" " " The current low count limit is displayed, press <b>[CE]</b> to clear and change if needed. If using net weight the display will show "Lo WEG"
Press <b>[Print]</b>	Return to weighing with limits set.

Clearing of either or both the limits is allowed. Both limits cleared will disable the Preset altogether.

If Preset Weight was selected the first display would show "Hi WEG" and "Lo WEG".

The beeper will work as described in the Beeper Parameter.



## 7.4 PLU (Product Look Up)

Product Look-Up (PLU) numbers are used to store information about the commonly used items. The Tare Weight, Description of the product and Unit Weights for a particular item are recalled by entering the PLU number for ease of operation.

The scale is capable of storing values for the Tare weight, Description and Unit Weight for a maximum of up to 100 PLU numbers.

Tare Weight value is required for calculating the Net Weight where a container is used during weighing. Descriptions are used for sending data over RS-232 for viewing or printing and Unit Weight is used for parts counting.

**These data should be entered against a particular PLU before the weighing process starts so that the desired PLU's can be recalled during the weighing process. The data can be stored and recalled manually or by sending data over RS-232 Interface.**

### 7.4.1 Storing plu's manually

ACTIONS	DISPLAYS			REMARKS
	Weight	Unit weight	Count	
Press [Tare/Zero] if required.	"0.0000"	" 0"	" 0"	The scale is zeroed.
<p><b>Note:</b></p> <p>Enter or determine the Tare Weight when a container is to be used (see section 7.2 of this User Manual). If a Tare value is used, the scale will be in the NET mode.</p> <p>Enter or determine the Unit Weight as described in section 7.3.1 and 7.3.2 of this User Manual.</p> <p>The Tare and Unit Weight to be stored can be either taken from a weighing in process or by manual entry of data.</p>				

Please find below an example for setting up “PLU 27” with Description as “M4 Nut” and Unit weight of “0.015”.

ACTIONS	DISPLAYS			REMARKS
	Weight	Unit weight	Count	
Press [PLU]	“PLU ”	“ _ _ ”	“ ”	-
Press [2], [7]	“PLU ”	“ 27 ”	“ ”	-
Press [Pst]	“PLU 27”	“x x x x x”	“x x x”	The current description will be shown with the first character flashing. The flashing digit can be changed as stated in the <b>Note</b> below.
Pressing the [CE] key when the first character is flashing will clear all the descriptions.	“PLU 27 ”	“ ”	“ ”	-
Continue to enter characters until description is complete.	“PLU 27 ”	“M 4 Nut”	“Brass ”	12 characters in total spreading over both the displays (UNIT WEIGHT and COUNT).
Press [Print] to save the PLU.	“STOrE”	“PLU ”	“ 27 ”	The display will show the PLU is saved then return to normal weighing mode.

**Note:**

Use the [.] key to go back to the previous digit or the [M+] key to advance to the next character.

A flashing character can be used for entering a space by pressing the [0] key for slightly longer duration.

Tare value will only be stored with PLU data if the scale is in the NET mode. If the container is less than the manual zero range which is set in "Technical parameters" (default is 2% of capacity) then the scale will be Zeroed and no tare value will be stored. To avoid this, use a larger container, reduce the zero range or use the digital tare method.

### 7.4.2 Entering description manually

The description can be up to 12 characters long and can be a mix of numbers, symbols or letters.

During the procedure to set the description the numeric keypad will work in a similar way to a mobile telephone. Pressing a number briefly will show the number and holding it down will scroll through all the characters.

The numbers and characters are:

1 - / \  
2 A B C  
3 D E F  
4 G H I  
5 J K L  
6 M N O  
7 P Q R S  
8 T U V  
9 W X Y Z  
0 [ ] Where \_ is a Space (Not underscore)

The limitations of the 7 segment display sometimes make it difficult to display some letters. The characters and the displayed symbols are:



The characters will be stored as text so the output of the RS-232 interface will look correct.

The numbers 1 2 3 4 5 6 7 8 9 0 will be 1 2 3 4 5 6 7 8 9 0.

Note that this method is only used where alpha-numeric data is permitted. This is used for the Description field and the User ID number, Scale ID number in the parameters section.

### 7.4.3 RECALLING PLU'S MANUALLY

To recall the PLU values the user should first select either local or remote scale as the tare value stored will be specific to the scale selected.

Then press the **[PLU]** key, enter the PLU number (00 – 99) then press the **[PLU]** key again to recall the data.

The display will show the results of the recall for 1 second then return to weighing with the data in place.

For example:

ACTIONS	DISPLAYS		
Press <b>[PLU]</b>	"PLU "	" _ _"	" "
Press <b>[2], [7]</b>	"PLU "	" 27"	" "
Press <b>[PLU]</b>	"PLU 27 "	"M 4 Nut"	"Brass "
After 1 second, it will return to normal weighing with the Tare and Unit Weight previously entered.	" x x x x"	" x x x x "	" x x"

If the **[PLU]** key is held down after the numeric entry, it will show the description as long as the key is pressed.

In this example the display "PLU 27 " "M 4 Nut" "Brass " shows the description for 1 second, if no data is stored then it will show  
 "nO " "PLU " "SAVE ".

If the tare value is outside the range permitted for the selected scale (For example, if the local scale is selected whereas the tare value applies to the remote scale, this would exceed the capacity of the local scale) the **"Weight"** display would show zero tare weight.

If the tare value stored does not match the increment of the selected scale (For example, storing -1.446 for a scale with d=0.05) then round the tare weight depending on the scale resolution (For example, in this case, -1.45 would be used as the tare value).

If a PLU number is recalled that does not have any information stored against it, the scale will continue to work with Tare and Unit weight unchanged.

**NOTE: PLU's can be stored and recalled using RS-232 Interface (see section 10.1 and 10.2 of this user Manual).**

## 8.0 PARAMETERS

The following parameters set up the scale as required by the user. For the Technical parameters and configuring the remote platform refer to Section 13.

Enter the User Parameters section by pressing the **[Pst]** key during the self-test when the power is turned on or press and hold the **[Pst]** key for 3 seconds during normal operation. This will allow the user to set the way he wants the scale to work by choosing specific values from some options.

- Press the **[U.Wt./Units]** key to scroll through the main parameters. To enter any parameter, press the **[Print]** key.
- Press **[U.Wt./Units]** to scroll through the sub-parameters. To see the earlier setting, press the **[Print]** key. To change and scroll through the other available settings, press **[U.Wt./Units]**. To choose the desired setting and thereby go back to the sub-parameter, press the **[Print]** key.
- To return to the parameter, press the **[Tare/Zero]** key.

PARA-METER	SUB-PARAMETER	DISPLAYS AND SETTINGS	
F1 oFF	bEEP	"bEEP" "oFF"	Beeper is set to off
		"bEEP" "on In "	Beeper is set to on between limits
		"bEEP" ""on oUt" "	Beeper is set to on outside limits (>0)
	EL	"LitE" ""oFF"	Backlight is set to off
		"LitE" "on"	Set to on at all times
		"LitE" "AUt"	Set to work automatically when a weight is placed on the scale or a key is pressed.

	<b>Un I t</b>	<b>"Unl t" " KG/ Lb"</b>	kg/ lb both are enabled
		<b>"Unl t" "KiLo"</b>	kg only is enabled
		<b>"Unl t" "Lb"</b>	lb only is enabled
<b>F2 Prt</b>	<b>P Mo dE</b>	<b>Print</b>	<b>Au Off</b> Prints only when the Auto-Accumulation is set to off. <b>Au on</b> Prints only when the Auto-Accumulation is set to on.
		<b>P Cont</b>	Sets the RS-232 interface to print continuously and the accumulation function is disabled.
		<b>SEr r E</b>	Sets the RS-232 to print continuously the weight only.
	<b>P bAU d</b>	<b>b 600</b> <b>b 1200</b> <b>b 2400</b> <b>b 4800</b> <b>b 9600</b> <b>b 19200</b>	Sets the required baud rate (speed for the RS-232 communications). Default rate is 4800.
	<b>PAritY</b>	<b>8 n 1</b> <b>7 E 1</b> <b>7 o 1</b>	8 data bits, no parity 7 data bits, even parity 7 data bits, odd parity
<b>F3 U id</b>	<b>"USE id"</b> <b>" Abc234"</b> <b>" "</b>	Shows the current user ID (if any). Enter a new User ID as described in the Description under the PLU section. The ID can be alpha-numeric but is limited to 6 characters.	
<b>F4 S id</b>	<b>"SC id"</b> <b>" Abc678"</b> <b>" "</b>	Shows the current scale ID (if any). Enter a new Scale ID as described in the Description under the PLU section. The ID can be alpha-numeric but is limited to 6 characters.	
<b>tECH</b>		Allows access to the Technical parameters using a password. Not normally accessed by user. See Section 13.	

## 8.1 REAL TIME CLOCK

The Real Time Clock (RTC) is used only for the RS-232 output. See Section 10. The Date and Time can be set as required. The scale will keep the clock running even when the power is off.

### Setting up the clock

- Press the **[CE]** key when the display is counting down after power is turned on. The initial displays show the current date and time.

“ rtC “ “11,14,06” “16,41,35”

- Press the **[Tare]** key to accept the values shown without change or press the **[U.Wt./Units]** key to change the time. The displays display will show the current time, “ timE “ “ H-m-S “ “16,41,35”
- Continue without changing the time or Enter the new time using the numeric keys using a 24 hour clock format, 3:41PM is “154100”.
- Press the **[Print]** key to accept the time. The display will show the current date format. Press the **[U. Wt./Units]** key to change the date format. Available formats are:

“Y-m-d” year, month, day

“m-d-Y” month, day, year

“d-m-Y” day, month, year

The Unit Weight display will show the current format, “Y-m-d” for example.

- Press the **[Tare]** key to accept the chosen format, the Count display will show the current settings. Enter the date in this format.
- Press the **[CE]** key to clear the current setting then enter the new values.
- Press the **[Tare]** key to accept the date.

An error code will be shown if the time (Err 1) or the date (Err 2) is not the permissible values. For example, 34<sup>th</sup> day of a month is an invalid entry.

Pressing the **[Zero]** key will escape for the date and time settings with the current values unchanged. It is possible to change only the time by setting a new time, then pressing the **[Zero]** key when the date settings are shown.

## 9.0 BATTERY OPERATION

The scales can be operated from the battery. The battery life is approximately 70 hours if only the basic unit is used and the backlight is not used. If the backlight and a second platform is used the battery life will be reduced.

When the battery needs charging the arrow above the low battery symbol under the “**Weight**” display will turn on. The battery should be charged as soon as the arrow above the symbol is on. The scale will still operate for about 10 hours after which it will automatically switch off to protect the battery.

To charge the battery simply plug into the mains power. The scale need not to be turned on.

The battery should be charged for 12 hours for full capacity.

Just under the “**Count**” display is an LED to indicate the status of battery charging. When the scale is plugged into the main power the internal battery will be charged. If the LED is green the battery has a full charge. If it is red, the battery is nearly discharged and yellow indicates the battery is nearly charged.



## 10.0 RS-232 OUTPUT

### Specifications:

RS-232 output of weighing, data default settings  
ASCII code  
4800 Baud (600-9600 selectable)  
8 data bits (8 data bits no parity, 7 data bits even and odd parity selectable)

### RS-232 Connector style:

9 pin D-subminiature socket  
Pin 2 Input  
Pin 3 Output  
Pin 5 Signal Ground

### USB Connector style:

Type B USB connector

Software drivers for allowing a PC to operate with the USB interface is available for the Adam Equipment web site.

The RS-232 and USB interfaces are the same for input and output.

### Sample of output:

Using M+ function	Using PRINT function
DATE 01/27/2011 TIME 12:38:49 LOCAL SCALE SID: ABS123  UID: 123ABC  NAME: Text  4 S. No.  1.234 kg TARE 12.456 kg NET 1.1234 g U.W.  11 PCS  TOTAL ----- 49.824 kg TW 44 TPC 4 No.	DATE 01/27/2011 TIME 12:39:58 LOCAL SCALE SID: ABS123  UID: 123ABC  NAME: Text  1.234 kg TARE 12.456 kg NET 1.1234 g U.W.  11 PCS

## 10.1 INPUT COMMANDS FORMAT

The scale can be controlled with the following commands.

Input Commands:

- The scale has a number of commands to either cause an action or to enter data into memory. The commands are all upper case and are summarised below.
- All commands are terminated by a carriage return (Enter button on PC keyboard) with the line feed optional.
- If an illegal command is received or a command cannot be carried out then send the command back with the addition of ER in front of it. For example if the command is NN<cr><lf> send back ER NN<cr><lf>.

Basic Commands:

PLUxx	Select PLU from scale memory to be used
T	Tare current weight value
T123.456	preset tare value is 123.456
Z	Zero the display
P	Print using selected format
M+	Store current results into memory and print
MR	Recall memory values to scale display
MC	Clear memory
U123.456	Store unit weight of 123.456 (grams if in kilograms or pounds if currently in pounds)
S123	Enter sample size of 123 parts. Same as pressing <b>[Smpl]</b> key.
SL	Select local scale to be used
SR	Select remote scale to be used

Immediate Printing Commands:

Command	Output from scale
\L	Scale: Local or Remote
\I	ID number same as PUID below
\S	Scale number same as PSID below
\N	Net weight
\G	Gross Weight
\T	Tare weight
\U	Unit weight
\P	Count
\C	Total Count
\W	Total Weight
\M	Number of items stored in memory
\B	A blank line printed

## 10.2 STORING DATA VIA RS232

To store data the commands are:

SUIDxxxxxx <CR>	Store user ID data
SSIDxxxxxx <CR>	Store scale ID data
SPLUxx,xxxxxxxxxxxxx <CR>	Store text data for PLUxx

When PLU text data is stored the Scale stores current unit weight and current tare value along with the PLU number.

For the SPLU command the data is: PLU number (2 characters), (Comma) description (max 12 characters).

If the fields are less than the maximum all characters need not be used.

## 10.3 PLU ENTRY USING RS-232 INTERFACE

This method enables the user to send the data from a PC program as well as from the keypad. The most common PLUs can be stored and recalled from the scale memory. Other PLU data can be stored on a PC, then the Description (text data), Unit Weight and Tare Weight data can be sent from the PC for the PLUxx (where xx can be any desired number up to 99). This can then be used or over-written during operation.

### OPERATION:

- Send Tare Weight data to set any tare value to be stored with PLU. i.e. "T 1.45" <CR>. If no tare is needed then you may send "T 0" to delete any present tare data.
- Send the Unit Weight to be stored with PLU. i.e. "U0.015" <CR>
- Send PLU text data to be stored with current Tare and U/W values. i.e. "SPLU27, M4 Nut Brass" <CR>

Any information stored for the Tare Weight, Description and the Unit weight will be stored in the scale and can be recalled for use in the future.

## 11.0 CALIBRATION

ACTION	DISPLAYS
Press the <b>[Tare/Zero]</b> key during the self-test at power on. The scale will ask to enter the password.	" Pi n"
Default Password is 0000. Enter "0" four times. Password can be changed in technical parameters. Press <b>[Print]</b> .	" Pi n" " _ _ _ _"
Select the scale to be set up by using the <b>[Local/Remote]</b> key. Press the <b>[Print]</b> key to enter the technical section.	"tECH" " LocAL" " " "tECH" "rEmo tE" " "
Use the <b>[U.Wt.]</b> to select the weighing unit to be used for setting the calibration for the scale. The arrow in the "Weight" window will indicate the unit selected. Press the <b>[Print]</b> key to continue.	"tECH" " Uni t" " "
You will enter the first parameter -Calibration. Display will ask to unload any weight on the platform. Press the <b>[Print]</b> key to continue.	"nO L o Ad"
Load the calibration weight onto the scale  If the mass is different than the value shown press the <b>[CE]</b> key then enter the calibration weight to be used.  Then press <b>[Print]</b> .	"LoAd " " 0010" " KiLoS"
The Calibration is complete, the scale will run the self-test during which the weight should be removed.  If calibration is not possible an error message will be shown	" _ _ _ _" " _ _ _ _" " _ _ _ _" "SPAn" " PASS" " "  "SPAn" " FAiL" " LoW " or "HiGH

If The Calibration is being done while in the TECH parameters (section 13) the linearity is set at the same time as calibration by performing the calibration in 2 steps,

<p>Display will ask to unload any weight on the platform. Press the <b>[Print]</b> key to continue.</p>	<p><b>"nO L o Ad"</b></p>
<p>Load the first calibration weight onto the scale</p> <p>If the mass is different than the value shown press the <b>[CE]</b> key then enter the calibration weight to be used.</p> <p>Then press <b>[Print]</b> to continue or press [Zero] to complete with only one mass being used.</p>	<p><b>"LoAd 1 " " 0010" " KiLoS"</b></p>
<p>Load the second calibration weight onto the scale</p> <p>If the mass is different than the value shown press the [CE] key then enter the calibration weight to be used.</p> <p>Then press [Print].</p>	<p><b>"LoAd 2" " 0030" " KiLoS"</b></p>
<p>The Calibration is complete, the scale will run the self-test during which the weight should be removed.</p>	<p><b>"_ _ _ _" " _ _ _ _" " _ _ _ _"</b>  <b>"SPAn" " PASS" " "</b></p> <p><b>If calibration is not possible an error message will be shown</b>  <b>"SPAn" " FAiL" " LoW " or "HiGH</b></p>

## 12.0 ERROR CODES

During the initial power-on testing or during the operation, the scale may show an error message. The meaning of the error messages are described below.

If an error message is shown, repeat the procedure that caused the message, such as turning the balance on, calibration or any other functions. If the error message is still shown then contact your dealer for further support.

ERROR CODE	DESCRIPTION	POSSIBLE CAUSES
<b>Err 4</b>	Initial Zero is greater than the permissible value (typically 4% of maximum capacity) when power is turned on or when the <b>[Zero]</b> key is pressed,	Weight on the pan when turning the scale on.  Excessive weight on the pan when zeroing the scale.  Improper calibration of the scale.  Damaged load cell.  Damaged Electronics.
<b>Err 5</b>	Keyboard error.	Improper operation of the scale.
<b>Err 6</b>	A/D count is not correct when turning the scale on.	Platform is not installed.  Load cell may be damaged.  Electronics may be damaged.
<b>FAIL HiGH or FAIL LoW</b>	Calibration error	Improper calibration.  If the problem persists contact your dealer or Adam Equipment for assistance.

### 13.0 TECHNICAL PARAMETERS

The technical parameters accessed via the “tECH” prompt at the end of user parameters and are password controlled to prevent unauthorised access. These parameters set the metrology for the scales. Each scale is set independently. The parameters will set capacity, division, decimal point position, initial zero range, auto and manual zero range as well as factory calibration.

ACTION	DISPLAYS
When “tEch” is displayed, press the <b>[Print]</b> key. The scale will ask you to enter the password.	“ Pi n”
Default Password is 0000. Enter “0” four times. 2006 will override any other user password. Press <b>[Print]</b> .	“ Pi n” “ ----”
Select the scale to be set up by using the <b>[Local/Rem]</b> key.  Press the <b>[Print]</b> to enter the technical section for that scale.	“t ECH” “ Lo c A L” “ “ “t ECH” “r E mo t E” “ “
Use the <b>[U.Wt./Units]</b> to select the weighing unit to be used for setting up the parameters for the scale. The arrow in the “ <b>Weight</b> ” window will indicate the unit selected. Press the <b>[Print]</b> key to continue.	“t ECH” “ Uni t” “ “
Press the <b>[U.Wt./Units]</b> key to scroll through the menus for the chosen scale. User <b>[Print]</b> to select and set parameters and the <b>[Tare/Zero]</b> to escape as without changing data as with the user parameter section.	“Cn t”  Both scales have the same menus except that the capacity of the local scale is fixed and cannot be entered.

<p>Press the <b>[U.Wt/Unit]</b> to go to next menu.  Press <b>[Print]</b> to enter.  Use <b>[U.Wt/Unit]</b> to select the decimal point position and press <b>[Print]</b>.  To change the remote scale cap press CE to clear and then enter new value followed by <b>[Print]</b>.</p>	<p><b>"CAP"</b> Scale capacity setting.   <b>"dESC" " 0.00"</b>   <b>"LOAD" "0060"</b></p>
<p>Press <b>[U.Wt/Unit]</b> to go to next menu. Press <b>[Print]</b> to enter.  Use <b>[U.Wt/Unit]</b> to select the division which you would like the display to increment in, followed by <b>[Print]</b>.</p>	<p><b>"inC 5"</b></p>
<p>Press the <b>[U.Wt/Unit]</b> to go to next menu, use <b>[Print]</b> key to enter.  Use <b>[U.Wt/Unit]</b> to increment the values then <b>[Print]</b>.</p>	<p><b>"AZt"</b> Autozero tracking range.   Select from <b>0.5d, 1d, 2d, 4,d</b></p>
<p>Press the <b>[U.Wt/Unit]</b> to go to next menu, use <b>[Print]</b> key to enter.  Use <b>[U.Wt/Unit]</b> to increment the values then <b>[Print]</b>.</p>	<p><b>"0 Auto"</b> Zero auto range at power on.   Select from <b>0%, to 10%</b></p>
<p>Press the <b>[U.Wt/Unit]</b> to go to next menu, use <b>[Print]</b> key to enter.  Use <b>[U.Wt/Unit]</b> to increment the values then <b>[Print]</b>.</p>	<p><b>"0 manl"</b> Zero manual range.   Select from <b>0%, to 10%</b></p>
<p>Press the <b>[U.Wt/Unit]</b> to go to next menu, use <b>[Print]</b> key to enter.  Enter the new PIN number and press <b>[Print]</b>.  Confirm the new PIN number and press <b>[Print]</b>.</p>	<p><b>"Pin"</b> Password number for <b>"tEch"</b>.   <b>"Pin1"</b>   <b>"Pin2"</b>  <b>"donE"</b></p>
<p>Press <b>[U.Wt./Units]</b> to continue use <b>[Print]</b> key to enter.  Escape the parameters with the <b>[Zero/Tare]</b></p>	<p><b>"CAL"</b> Enter calibration section where the local or remote scale is selected. See section 11.</p>



## 14.0 REPLACEMENT PARTS AND ACCESSORIES

If you need to order any spare parts and accessories, contact your supplier or Adam Equipment. A partial list of such items is as follows-

- Power Supply Module
- Main Power cord
- Replacement Battery
- Stainless Steel Pan
- In use cover
- Printer, etc.

## 15.0 SERVICE INFORMATION

This manual covers the details of operation. If you have a problem with the scale that is not directly addressed by this manual then contact your supplier for assistance. In order to provide further assistance, the supplier will need the following information which should be kept ready:

### A. Details of your company

- Name of your company:
- Contact person's name:
- Contact telephone, e-mail, fax or any other methods:

### B. Details of the unit purchased

(This part of information should always be available for any future correspondence. We suggest you to fill in this form as soon as the unit is received and keep a print-out in your record for ready reference.)

<b>Model name of the scale:</b>	<b>CBD_____</b>
<b>Serial number of the unit:</b>	
<b>Software revision number (Displayed when power is first turned on):</b>	
<b>Date of Purchase:</b>	
<b>Name of the supplier and place:</b>	

### C. Brief description of the problem

Include any recent history of the unit. For example:

- Has it been working since it's delivered
- Has it been in contact with water
- Damaged from a fire
- Electrical Storms in the area
- Dropped on the floor, etc.

## **WARRANTY INFORMATON**

Adam Equipment offers Limited Warranty (Parts and Labour) for any components that fail due to defects in materials or workmanship. Warranty starts from the date of delivery.

During the warranty period, should any repairs be necessary, the purchaser must inform its supplier or Adam Equipment. The company or its authorised technician reserves the right to repair or replace the components at the purchaser's site or any of its workshops depending on the severity of the problems at no additional cost. However, any freight involved in sending the faulty units or parts to the service centre will be borne by the purchaser.

The warranty will cease to operate if the equipment is not returned in the original packaging and with correct documentation for a claim to be processed. All claims are at the sole discretion of Adam Equipment.

This warranty does not cover equipment where defects or poor performance is due to misuse, accidental damage, exposure to radioactive or corrosive materials, negligence, faulty installation, unauthorised modifications or attempted repair or failure to observe the requirements and recommendations as given in this User Manual.

This product may include a rechargeable battery that is designed to be removed and replaced by the user. Adam Equipment warrants that it will provide a replacement battery if the battery manifests a defect in materials or workmanship during the initial period of use of the product in which the battery is installed.

As with all batteries, the maximum capacity of any battery included in the product will decrease with time or use, and battery cycle life will vary depending on product model, configuration, features, use, and power management settings. A decrease in maximum battery capacity or battery cycle life is not a defect in materials or workmanship, and is not covered by this Limited Warranty.

Repair carried out under the warranty does not extend the warranty period. Components removed during the warranty repairs become the company property.

The statutory rights of the purchaser are not affected by this warranty. In the event of dispute then the terms of this warranty are governed by UK law. For complete details on Warranty Information, see the terms and conditions of sale available on our web-site.

**[www.adamequipment.com](http://www.adamequipment.com)**

## WEEE 2012/19/EU

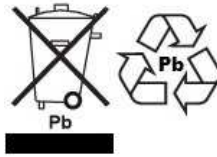

This device may not be disposed of in domestic waste. This also applies to countries outside the EU, per their specific requirements. Disposal of batteries (if fitted) must conform to local laws and restrictions.

Cet appareil ne peut être éliminé avec les déchets ménagers. L'élimination de la batterie doit être effectuée conformément aux lois et restrictions locales.

Dieses Gerät nicht mit dem Hausmüll entsorgt.

Dispositivo no puede ser desechado junto con los residuos domésticos

Dispositivo non può essere smaltito nei rifiuti domestici.

### FCC / IC CLASS A DIGITAL DEVICE EMC VERIFICATION STATEMENT

NOTE: This equipment has been tested and found to comply with the limits for a Class A digital device, pursuant to Part 15 of the FCC rules and Canadian ICES-003/NMB-003 regulation. These limits are designed to provide reasonable protection against harmful interference when the equipment is operated in a commercial environment. This equipment generates, uses and can radiate radio frequency energy and, if not installed and used in accordance with the instruction manual, may cause harmful interference to radio communications. Operation of this equipment in a residential area is likely to cause harmful interference in which case the user will be required to correct the interference at his own expense.

### CALIFORNIA PROPOSITION 65 - MANDATORY STATEMENT

WARNING: This product includes a sealed lead-acid battery which contains chemicals known to the State of California to cause cancer and birth defects or other reproductive harm.



Adam Equipment products have been tested with, and are always supplied with mains power adaptors which meet all legal requirements for the intended country or region of operation, including electrical safety, interference and energy efficiency. As we often update adaptor products to meet changing legislation it is not possible to refer to the exact model in this manual. Please contact us if you need specifications or safety information for your particular item. Do not attempt to connect or use an adaptor not supplied by us.

**ADAM EQUIPMENT** is an ISO 9001:2008 certified global company with more than 40 years' experience in the production and sale of electronic weighing equipment.

Adam products are predominantly designed for the Laboratory, Educational, Health and Fitness, Retail and Industrial Segments. The product range can be described as follows:

- Analytical and Precision Laboratory Balances
- Compact and Portable Balances
- High Capacity Balances
- Moisture analysers / balances
- Mechanical Scales
- Counting Scales
- Digital Weighing/Check-weighing Scales
- High performance Platform Scales
- Crane scales
- Mechanical and Digital Electronic Health and Fitness Scales
- Retail Scales for Price computing

For a complete listing of all Adam products visit our website at  
[www.adamequipment.com](http://www.adamequipment.com)

<p><b>Adam Equipment Co. Ltd.</b>  Maidstone Road, Kingston  Milton Keynes  MK10 0BD  UK  Phone: +44 (0)1908 274545  Fax: +44 (0)1908 641339  e-mail:  <a href="mailto:sales@adamequipment.co.uk">sales@adamequipment.co.uk</a></p>	<p><b>Adam Equipment Inc.</b>  1, Fox Hollow Rd.,  Oxford, CT  06478  USA  Phone: +1 203 790 4774  Fax: +1 203 792 3406  e-mail:  <a href="mailto:sales@adamequipment.com">sales@adamequipment.com</a></p>	<p><b>AE Adam GmbH.</b>  Instenkamp 4  D-24242 Felde   Germany  Phone +49 (0)4340 40300 0  Fax: +49 (0)4340 40300 20  e-mail:  <a href="mailto:vertrieb@aeadam.de">vertrieb@aeadam.de</a></p>
<p><b>Adam Equipment S.A. (Pty) Ltd.</b>  7 Megawatt Road,  Spartan EXT 22  Kempton Park,  Johannesburg,  Republic of South Africa   Phone +27 (0)11 974 9745  Fax: +27 (0)11 392 2587  e-mail:  <a href="mailto:sales@adamequipment.co.za">sales@adamequipment.co.za</a></p>	<p><b>Adam Equipment (S.E. ASIA) PTY Ltd</b>  2/71 Tacoma Circuit  CANNING VALE 6155  Perth  Western Australia   Phone: +61 (0) 8 6461 6236  Fax +61 (0) 8 9456 4462  e-mail:  <a href="mailto:sales@adamequipment.com.au">sales@adamequipment.com.au</a></p>	<p><b>Adam Equipment (Wuhan) Co. Ltd.</b>  A Building East Jianhua  Private Industrial Park  Zhuanyang Avenue  Wuhan Economic &amp; Technological  Development Zone  430056 Wuhan  P.R.China  Phone: + 86 (27) 59420391  Fax + 86 (27) 59420388  e-mail:  <a href="mailto:info@adamequipment.com.cn">info@adamequipment.com.cn</a></p>

© Copyright by Adam Equipment Co. All rights reserved. No part of this publication may be reprinted or translated in any form or by any means without the prior permission of Adam Equipment.

Adam Equipment reserves the right to make changes to the technology, features, specifications and design of the equipment without notice.

All information contained within this publication is to the best of our knowledge timely, complete and accurate when issued. However, we are not responsible for misinterpretations which may result from the reading of this material.

The latest version of this publication can be found on our Website.

[www.adamequipment.com](http://www.adamequipment.com)