

CBC SERIES

Software rev: 5.08 & above

Easy Reference:

Model name of the scale:	
Serial number of the unit:	
Software revision number (Displayed when power is first turned on):	
Date of Purchase:	
Name of the supplier and place:	

CONTENTS

P.N. 8680, Revision D1, August 2017

1.0	INTRODUCTION	3
2.0	SPECIFICATIONS	5
2.1	COMMON SPECIFICATIONS	6
3.0	INSTALLATION	7
3.1	LOCATING THE SCALE	7
3.2	INSTALLATION OF CBC SCALES	7
4.0	KEY DESCRIPTIONS	8
5.0	DISPLAYS	9
5.1	WEIGHT DISPLAY	9
5.2	UNIT WEIGHT DISPLAY	9
5.3	COUNT DISPLAY	10
6.0	OPERATION	10
6.1	ZEROING THE DISPLAY	10
6.2	TARING	10
6.3	PARTS COUNTING	11
6.3.1	Setting Unit Weight	11
6.3.2	Counting more parts	12
6.3.3	Automatic part weight updates	12
6.3.4	Check-counting	13
6.3.5	Manually Accumulated Totals	13
6.3.6	Automatic Accumulated Totals	14
7.0	PARAMETERS	14
8.0	CALIBRATION	15
9.0	RS-232 INTERFACE	17
9.1	INPUT COMMANDS FORMAT	19
9.2	RS-232 SETUP	19
10.0	CLOCK, SLEEP, AUTO OFF FUNCTIONS	22
10.1	REAL TIME CLOCK SETUP	22
10.2	AUTO SLEEP FUNCTION	23
10.3	BACKLIGHT FOR LCD	23
10.4	BATTERY	24
11.0	ERROR CODES	25
12.0	REPLACEMENT PARTS AND ACCESSORIES	26
13.0	SERVICE INFORMATION	26

1.0 INTRODUCTION

- The **CBC** series provides accurate, fast and versatile counting scales.
- There are 2 type of scales within the **CBC** series-

CBC scales are gram/ kilogram only scales and the **CBCa** scales are changeable from pounds to kilograms. The scales have the same functions except that **CBCa** scales have the ability to toggle between the two weighing units.

- There are 5 models in each type with capacities up to 48 kg / 100lb.
- The scales have stainless steel weighing platforms on an ABS base assembly.
- All scales are supplied with a RS-232 bi-directional interface and real time clock (RTC).
- The scales have sealed keypad with colour coded membrane switches and there are 3 large, easy to read liquid crystal type displays (LCD). The LCD's are supplied with a backlight.
- The scales include automatic zero tracking, audible alarm for pre-set counts, automatic tare, pre-set tare, an accumulation facility that allows the count to be stored and recalled as an accumulated total.

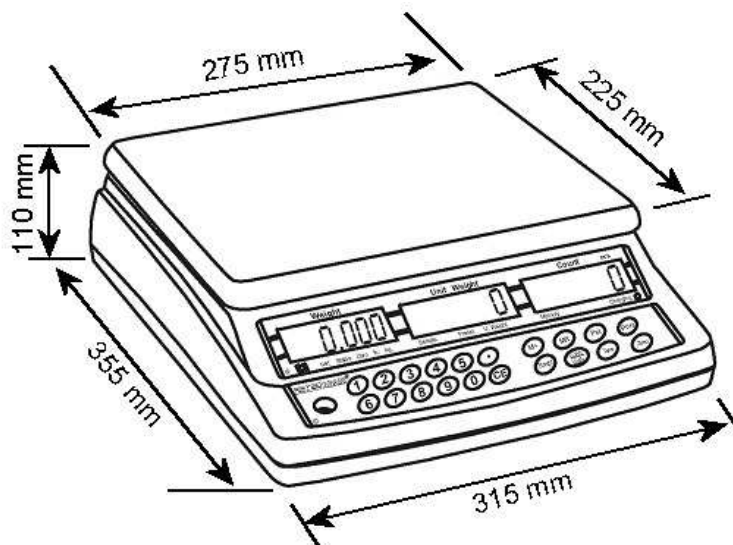

2.0 SPECIFICATIONS

CBC SERIES					
Model #	CBC 4	CBC 8	CBC 16	CBC 32	CBC 48
Maximum Capacity	4000 g	8000 g	16kg	32 kg	48 kg
Readability	0.1 g	0.2 g	0.0005 kg	0.001 kg	0.002 kg
Tare Range	-4000 g	-8000 g	-9.9995 kg	-32 kg	-48 kg
Repeatability (Std Dev)	0.1 g	0.2 g	0.0005 kg	0.001 kg	0.002 kg
Linearity ±	0.2 g	0.4 g	0.001 kg	0.002 kg	0.004 kg
Units of Measure	g			kg	

CBCa SERIES

Model: CBC 8a

UNITS OF MEASURE	MAXIMUM CAPACITY	TARE RANGE	READABILITY	REPEATIBILITY	LINEARITY
Grams	4000 g	-4000 g	0.1 g	0.1 g	0.2 g
Pounds	8.0000 lb	-8 lb	0.0002 lb	0.0002 lb	0.0004 lb

Model: CBC 16a

UNITS OF MEASURE	MAXIMUM CAPACITY	TARE RANGE	READABILITY	REPEATIBILITY	LINEARITY
Grams	8000 g	-8000 g	0.2 g	0.2 g	0.4 g
Pounds	16.0000 lb	-9.9995 lb	0.0005 lb	0.0005 lb	0.001 lb

Model: CBC 35a

UNITS OF MEASURE	MAXIMUM CAPACITY	TARE RANGE	READABILITY	REPEATIBILITY	LINEARITY
Kilograms	16.0000 kg	-9.9995 kg	0.0005 kg	0.0005 kg	0.001 kg
Pounds	35.000 lb	-35 lb	0.001 lb	0.001 lb	0.002 lb

Model: CBC 70a

UNITS OF MEASURE	MAXIMUM CAPACITY	TARE RANGE	READABILITY	REPEATIBILITY	LINEARITY
Kilograms	32.000 kg	-32 kg	0.001 kg	0.001 kg	0.002 kg
Pounds	70.000 lb	-70 lb	0.002 lb	0.002 lb	0.004 lb

Model: CBC 100a

UNITS OF MEASURE	MAXIMUM CAPACITY	TARE RANGE	READABILITY	REPEATIBILITY	LINEARITY
Kilograms	48.000 kg	-48 kg	0.002 kg	0.002 kg	0.004 kg
Pounds	100 lb	-99 lb	0.005 lb	0.005 lb	0.01 lb

2.1 COMMON SPECIFICATIONS

Stabilisation Time	2 Seconds typical
Operating Temperature	-10°C - 40°C 14°F - 104°F
Power supply	230 VAC 50/60 Hz 120 VAC available
Battery	Internal rechargeable battery (~90 hours operation)
Calibration	Automatic External
Display	3 x 6 digits LCD digital displays
Balance Housing	ABS Plastic, Stainless Steel platform
Pan Size	225 x 275mm 8.9" x 10.8"
Overall Dimensions (wxdxh)	315 x 355 x 110mm 12.4" x 14" x 4.3"
Net Weight	4.4 kg / 9.7 lb
Applications	Counting Scales
Functions	Parts counting, check-counting, weighing, accumulating memory, pre-set count with alarm
Interface	RS-232 bi-directional interface English, German, French, Spanish selectable text
Date/Time	Real Time Clock (RTC), To print date and time information (Dates in year/month/day, day/month/year or month/day/year formats- Battery backed)

3.0 INSTALLATION

3.1 LOCATING THE SCALE

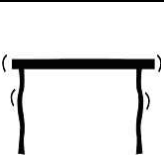
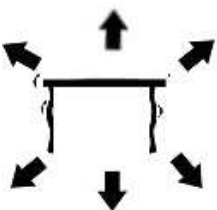
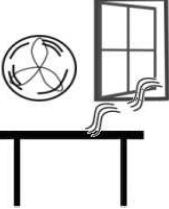
	<ul style="list-style-type: none">• The scales should not be placed in a location that will reduce the accuracy.• Avoid extremes of temperature. Do not place in direct sunlight or near air conditioning vents.
	<ul style="list-style-type: none">• Avoid unsuitable tables. The table or floor must be rigid and not vibrate.
	<ul style="list-style-type: none">• Avoid unstable power sources. Do not use near large users of electricity such as welding equipment or large motors.• Do not place near vibrating machinery.
	<ul style="list-style-type: none">• Avoid high humidity that might cause condensation. Avoid direct contact with water. Do not spray or immerse the scales in water.• Avoid air movement such as from fans or opening doors. Do not place near open windows or air-conditioning vents.
	<ul style="list-style-type: none">• Keep the scales clean. Do not stack material on the scales when they are not in use.

3.2 INSTALLATION OF CBC SCALES

- The **CBC** Series come with a stainless steel platform packed separately.
- Place the platform in the locating holes on the top cover.
- **Do not** press with excessive force as this could damage the load cell inside.
- Level the scale by adjusting the four feet. The scale should be adjusted such that the bubble in the spirit level is in the centre of the level and the scale is supported by all four feet.
- Turn the power ON using the switch located on the right side of the base.

- The scale will show the current software revision number in the “**Weight**” display window, for example **V3.06**.
- Next a self-test is performed. At the end of the self-test, it will display “**0**” in all three displays, if the zero condition has been achieved.

4.0 KEY DESCRIPTIONS

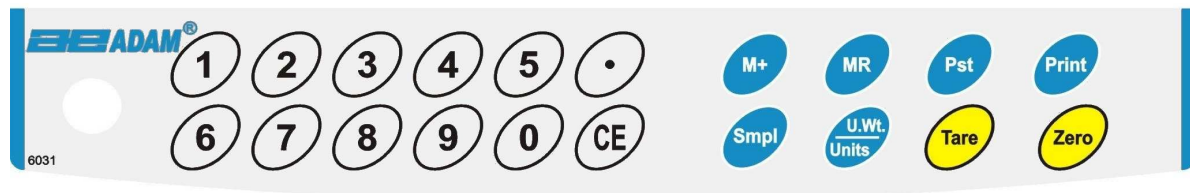

Keys	Functions
[0-9, .]	Numeric entry keys, used to manually enter a value for tare weights, unit weight, and sample size.
[CE]	Used to clear the unit weight or an erroneous entry.
[M+]	Add the current count to the accumulator. Up to 99 values or full capacity of the weight display can be added. Also prints the displayed values when Auto print is switched off.
[MR]	To recall the accumulated memory.
[Pst]	To set the upper limit for the number of items counted. When this upper limit is exceeded the scale will sound the beeper.
[Print]	To print the accumulated totals to a PC or printer using the RS-232 interface.
[Smpl]	Used to input the number of items in a sample.
[U.Wt./Units]	Used to enter the weight of a sample manually. For CBCa it will also select the weighing unit when the “ Unit Weight ” display is at zero.
[Tare]	Tares the scale. Stores the current weight in memory as a tare value, subtracts the tare value from the weight and shows the results. This is the net weight. Entering a value using the keypad will store that as the tare value.
[Zero]	Sets the zero point for all subsequent weighing to show zero.

5.0 DISPLAYS

The scales have three digital display windows. These are “**Weight**”, “**Unit Weight**” and “**Count**”.

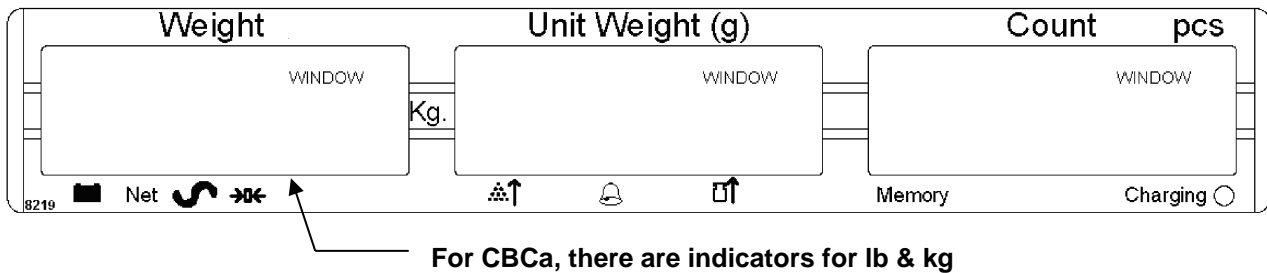

5.1 WEIGHT DISPLAY

It has 6-digit display to indicate the weight on the scale.

Arrows above symbols will indicate the following:

Low battery,  as above



Net Weight Display, "**Net**" as above

Stability indicator, "**Stable**" or symbol  as above

Zero indicator, "**Zero**" or symbol  as above

Note: Unit indicator “**lb/kg**” for **CBCa** only

5.2 UNIT WEIGHT DISPLAY

- This display will show the unit weight of a sample. This value is either input by the user or computed by the scale. The unit of measurement is grams on **CBC** and pounds on **CBCa** scales.
- The arrow indicator will be seen above "**Sample**" or  symbol as above, when there is insufficient number of samples to accurately determine the count.
- When the unit weight is not large enough to determine an accurate count, the arrow indicator will be seen above "**U. Weight**" or  symbol as above.
- In both cases the scale continues to operate and the indications are to alert the user for a potential problem.

- If a preset count has been stored the "**Preset**" or  symbol as above, will have an arrow above.

5.3 COUNT DISPLAY

- This display will show the number of items on the scale or the value of the accumulated count. See the next section on OPERATION.
- The arrow indicator will be seen above "**Memory**" when a value has been entered into the memory.

6.0 OPERATION

NOTE: CBCa Scales only

SETTING THE WEIGHING UNIT, lb or kg

The scale will turn on displaying the last weighing unit selected, either kilograms or pounds. To change the weighing unit press the **[U. Wt./Units]** key when the "**Unit Weight**" display shows zero. If necessary press the **[CE]** key to clear the unit weight before changing.

6.1 ZEROING THE DISPLAY

- You can press the **[Zero]** key at any time to set the zero point from which all other weighing and counting is measured. This will usually be necessary only when the platform is empty. When the zero point is obtained the "**Weight**" display will show the indicator for zero.
- The scale has an automatic re-zeroing function to account for minor drifting or accumulation of material on the platform. However you may need to press **[Zero]** to re-zero the scale if small amounts of weight are still shown when the platform is empty.

6.2 TARING

- Zero the scale by pressing the **[Zero]** key if necessary. The indicator above "**Zero**" will be ON.
- Place a container on the platform and its weight will be displayed.
- Press **[Tare]** to tare the scale. The weight that was displayed is stored as the tare value which is subtracted from the display, leaving zero on the display. The indicator above "**Net**" will be ON.

- As a product is added only the weight of the product will be shown. The scale could be tared a second time if another type of product was to be added to the first one. Again only the weight that is added after taring will be displayed.
- When the container is removed a negative value will be shown. If the scale was tared just before removing the container, this value is the gross weight of the container plus all products those were removed. The indicator above “**Zero**” will also be ON because the platform is back to the same condition as it was when the **[Zero]** key was pressed last.

6.3 PARTS COUNTING

6.3.1 Setting Unit Weight

In order to do parts counting it is necessary to know the average weight of the items to be counted. This can be done by weighing a known number of the items and letting the scale determine the average unit weight or by manually inputting a known unit weight using the keypad.

A. Weighing a sample to determine the Unit Weight

To determine the average weight of the items to be counted, you will need to place a known quantity of the items on the scale and then to key in the number of items being weighed. The scale will then divide the total weight by the number of items and display the average unit weight. Press **[CE]** anytime to clear the unit weight.

- Zero the scale by pressing the **[Zero]** key if necessary. If a container is to be used, place the container on the scale and tare by pressing **[Tare]** as discussed earlier.
- Place a known quantity of items on the scale. After the weight display is stable, enter the quantity of items using the numeric keys and then press the **[Smpl]** key.
- The number of units will be displayed on the “**Count**” display and the computed average weight will be shown on the “**Unit Weight**” display.
- As more items are added to the scale, the weight and the quantity will increase.
- If a quantity which is smaller than the sample is placed on the scale, then the scale will automatically enhance the Unit Weight

by re-calculating it. To lock the Unit Weight and avoid re-sampling, press **[U. Wt./Units]**.

- If the scale is not stable, the calculation will not be completed. If the weight is below zero, the "**Count**" display will show negative count.

B. Entering a known Unit Weight

- If the unit weight is already known then it is possible to enter that value using the keypad.
- Enter the value of the unit weight in grams, using the numeric keys followed by pressing the **[U. Wt./Units]** key. The "**Unit Weight**" display will show the value as it was entered.
- The sample is then added to the scale and the weight will be displayed as well as the quantity, based on the unit weight.

6.3.2 Counting more parts

- After the unit weight has been determined or entered, it is possible to use the scale for parts counting. The scale can be tared to account for the container weight as discussed in the earlier section.
- After the scale is tared the items to be counted are added and the "**Count**" display will show the number of items, computed using the total weight and the unit weight.
- It is possible to increase the accuracy of the unit weight at any time during the counting process by entering the count displayed and then pressing the **[Smpl]** key. You must be certain that the quantity displayed matches the quantity on the scale before pressing the key. The unit weight can be adjusted based upon a larger sample quantity. This will give greater accuracy when counting larger sample sizes.

6.3.3 Automatic part weight updates

- At the time of computing the unit weight (see section 6.3.1A), the scale will automatically update the unit weight when a sample less than the sample already on the platform is added. A beep will be heard when the value is updated. It is wise to check the quantity is correct when the unit weight has been updated

automatically.

- This feature is turned off as soon as the number of items added exceeds the count used as a sample.

6.3.4 Check-counting

- Check-counting is a procedure to cause an alarm to sound when the number of items counted on the scale meets or exceeds a number stored in the memory by using the **[Pst]** key.
- The value to be stored is entered from the keyboard. Enter the numeric value to be stored using the numeric keys. Then press the **[Pst]** key to store the value.
- To clear the value from the memory and thereby turn off the check-counting feature, enter the value "0" and press **[Pst]**.

6.3.5 Manually Accumulated Totals

- The values (weight and count) shown on the display can be added to the values in the memory by pressing the **[M+]** key. The "**Weight**" display will show the total weight, the "**Count**" display will show the total accumulated count and the "**Unit Weight**" display shows the number of times, the items have been added to the memory for accumulation. The values will be displayed for 2 seconds before returning to normal.
- The scale must return to zero or a negative number, before another sample can be added to the memory.
- More products can then be added and the **[M+]** key to be pressed again. This can continue for up to 99 entries or until the capacity of the "**Weight**" display is exceeded.
- To observe the total stored value, press the **[MR]** key. The total will be displayed for 2 seconds.
- To clear the memory- first press **[MR]** to recall the totals from memory and then press the **[CE]** key to clear all values from the memory.

6.3.6 Automatic Accumulated Totals

- The scale can be set to automatically accumulate totals when a weight is placed on the scale. This eliminates the need to press the **[M+]** key to store values into the memory. However the **[M+]** key is still active and can be pressed to store the values immediately. In this case the values will not be stored when the scale returns to zero.
- See the Section 9.0 on RS-232 Interface for details on how to enable Automatic Accumulation.

7.0 PARAMETERS

The parameters are set to customise the scale to suit the weighing applications. You need to enter a secure menu by entering a password when requested.

- Press **[Tare]** once, during the initial counting of the display after the power is turned on.
- The “**Weight**” display will show “**Pln**” requesting for the password number.
- The default password is “**0000**” but other numbers can be set using the parameter menus. Press the **[0]** key four times.
- Press the **[Tare]** key.
- There are 2 functions that can be cycled through using the **[U. Wt./Units]** key. The **Weight** window will show the parameter number and the **Unit Price** window will show the word describing the function.
- The first parameter is “**F1**” “**CAL**”. (See section 8.0 for details)
- To enter into Calibration function, press the **[Tare]** key.
- To exit a parameter, press the **[Zero]** key.
- To select the second parameter press the **[U. Wt./Units]** key.

SETTING OF PIN

- Display will show "**F2**" "**Pin**". This parameter allows setting of a new password number.
- Press [**Tare**]. The "**WEIGHT**" display will show "**Pin 1**"
- Enter the new password number. The "**Unit Weight**" display will show dashes. Press [**Tare**].
- The "**WEIGHT**" display will change to "**Pin 2** ", Enter the password again and press [**Tare**].
- The display will show "**done**" to show the new password has been accepted and will return to the menu. Record the new password in a secured place.
- To exit a parameter, press the [**Zero**] key.

8.0 CALIBRATION

- The **CBC** scales are calibrated using metric weights and **CBCa** scales are calibrated using metric or pound weights depending on the unit in use before calibration.
- The scale will display a value of the weight to be used for calibration. You can enter a different value, if desired.
- For entering Calibration, see section 7.0 Parameters
- When "**F1**" "**CAL**" is displayed, press [**Tare**].
- The display will then show "**unLoAd**" to request all weight be removed from the platform.
- Press the [**Tare**] key to set the zero point.

- The displays will then show the calibration weight suggested as a whole number. For example:

“LoAd”	“04”	“KiLoS”
---------------	-------------	----------------

Either put this weight on the platform after the stable symbol is on or enter the desired value in whole integer and then press **[Tare]**.

- Place the weight on the platform and press **[Tare]** again.
- At all times the scale should be stable before pressing the **[Tare]** key to accept a weight. The stability indicator will turn on to show the value is stable.
- When calibration is done the display will show **“SPAn” “PASS”**.
- Remove the weight. The scale will return to normal weighing.
- If an error message **“SPAn” “FAIL”** is displayed, then repeat the process.

Suggested Calibration weights for CBC Series:

CBC 4 / CBC 8a	CBC 8 / CBC 16a	CBC 16 / CBC 35a	CBC 32 / CBC 70a	CBC 48 / CBC 100a
2 kg / 5 lb	4 kg / 10 lb	10 kg / 30 lb	20 kg / 50 lb	30 kg / 100 lb

- After calibration, the scale should be checked whether the calibration and linearity is correct. If necessary, repeat calibration.

NOTE: CBCa scales will have the lb or kg indicator on, to show the unit of the weight requested. If the scale was in pounds before starting the calibration, the weights requested will be in pound values or if the scale was weighing in kilograms then metric weights will be requested.

9.0 RS-232 INTERFACE

The CBC Series are supplied with a RS-232 bi-directional interface. The scale when connected to a printer or computer through the RS-232 interface, outputs the weight, unit weight and count.

Specifications:

RS-232 output of weighing data ASCII code Adjustable Baud rate, 600, 1200, 2400, 4800, 9600 and 19200 baud 8 data bits No Parity
--

Connector:

9 pin D-subminiature socket Pin 3 Output Pin 2 Input Pin 5 Signal Ground

The scale can be set to print text in English, French, German or Spanish.

The data will normally output in a label format if parameter Label=On. This format is described below. See the RS-232 parameters section for details.

Data Format-Normal Output:

Date	12/09/2006	
Time	14:56:27	
<lf><cr>		
Gross Wt	1.234 Kg	Net Wt. for net weight (with tare value stored)
Unit Wt.	123 g	Kg and g for metric and lb for pounds.
PCS	10 pcs	
<lf><cr>		Includes 2 line feeds with carriage return
<lf><cr>		

Data Format- Memory Recall Print:

```

Date          12/09/2006
Time          14:56:27
<lf><cr>
*****
<lf> <cr>                                     Includes 1 line feed
TOTAL
No.           5
Wt.          1.234 Kg
PCS          10 pcs
<lf><cr>                                     Includes 1 line feed
*****
<lf><cr><lf><cr>                               2 line feeds, carriage return
    
```

Pressing the **[MR]** key will not send the totals to the RS-232 when the continuous print is turned on. The continuous print will only be for weight and display data that is current.

LABEL = Off single line output
 Fixed line width, leading zeros are spaces.

Data Format-Normal Output:

```

1.234 Kg,      10 pcs<lf><cr>
    
```

Data Format- Memory Recall Print:

```

TOTAL No.     5,    1.234 Kg,      10 pcs<lf><cr>
    
```

In other languages the format is the same but the text will be in the language selected.

Description	ENGLISH	FRENCH	GERMAN	SPANISH
Print gross weight	Gross Wt	Pds Brut	Brut-Gew	Pso Brut
Net weight	Net Wt.	Pds Net	Net-Gew	Pso Net
Weight per unit counted	Unit Wt.	Pds unit	Gew/Einh	Pso/Unid
Number of items counted	Pcs	Pcs	Stck.	Piezas
Number of weighings added to subtotals	No.	Nb.	Anzhl	Num.
Total weight	Total	Total	Gesamt	Total

and count printed				
Print date	Date	Date	Datum	Fecha
Print time	Time	Heure	Zeit	Hora

9.1 INPUT COMMANDS FORMAT

The scale can be controlled with the following commands. The commands must be sent in upper case letters, i.e. “**T**” not “**t**”. Press the Enter key of the PC after each command.

T<cr><lf>	Tares the scale to display the net weight. This is the same as pressing [Tare] key.
Z<cr><lf>	Sets the zero point for all subsequent weighing. The display shows zero.
P<cr><lf>	Prints the results to a PC or printer using the RS-232 interface. It also adds the value to the accumulation memory if the accumulation function is not set to automatic. In CBC series, the [Print] key will either print the current items being counted or the results of the accumulation memory if [M+] is pressed first.
R<cr><lf>	Recall and Print- Same as if first the [MR] key and then the [Print] key is pressed. Will display the current accumulated memory and print the total results.
C<cr><lf>	Same as pressing [MR] first and then the [CE] key to erase the current memory.

9.2 RS-232 SETUP

The RS-232 interface uses parameters set by the user for language, baud rate and date format.

Press and hold the **[Print]** key for 4 seconds to access the parameters. Press **[U. Wt./Units]** to scroll through the options and **[Tare]** to confirm the change and then advance to the next parameter.

When a parameter is entered by pressing **[Tare]**, the displays will guide you through the parameter selected and the options available.

The parameters and their functions are:

Displays			Options	Functions
Weight	Unit Weight	Count		
Port	On		On off	Enable or disable the RS-232 interface.
4800	bPS		600 1200 2400 4800 9600 19200	Set baud rate.
Print	mAn		Cont to PC Print Auto Print mAn	Select printing options for continuous printing, print automatically or printing manually.
AC	mAn		AC Auto AC mAn AC off	Select the operation of accumulating automatically, manually or turned off.
CoUntr	Y E	nGLiSH	EnGLiSH FrEnCH GErMAn SPAniSH	Select Language for printing.
LABEL	On		On Off	Set to print label format or single line.

The scale will perform the following functions depending on the Accumulation and Print settings:

	ACCUMULATION FUNCTIONS		
PRINT FUNCTIONS	AC Auto	AC mAn	AC off
Print Auto	Accumulate and print one time automatically Print again when [Print] key pressed,	Print one time automatically Accumulate and print when [M+] is pressed Print again when [Print] key pressed,	Print one time automatically, [M+] key has no function Print again when [Print] key pressed,
Print mAn	Automatically Accumulate but not print, Print when [Print] key pressed,	Accumulate and print when [M+] or [Print] is pressed Print again when [Print] key pressed,	Print when [Print] key is pressed, [M+] key has no function
Cont to PC	Print continuously and accumulate automatically when stable [Print] key no function	Print continuously and accumulate when [M+] is pressed [Print] key no function	Print continuously [M+] and [Print] key have no function

When the scale is at Zero the **[Print]** key will print weight at zero. After **[MR]** has been pressed the print key will print the accumulation memory results.

10.0 CLOCK, SLEEP, AUTO OFF FUNCTIONS

10.1 REAL TIME CLOCK SETUP

The Real Time Clock (RTC) is used only for the RS-232 output. The Date and Time can be set as required. The scale will keep the clock running even when the power is off.

Setting up the clock

- Press the **[CE]** key when the display is counting down after power is turned on. The initial displays show the current date and time set.

“ **rtc** ” “ **11,14,06** ” “ **16,41,35** ”

- Press the **[Zero]** key to accept the values shown without change or press the **[CE]** key to change the time or the **[Tare]** key to change the date only. The Unit Weight display will show the current time format, “**H-m-S**”.
- Enter the time using the numeric keys using a 24 hour clock format, 3:41PM is “**154100**”.
- Press the **[Tare]** key to accept the time. The display will show the current date format.
- Press the **[U. Wt./Units]** key to change the date format. Available formats are:

“**Y-m-d**” year, month, day

“**m-d-Y**” month, day, year

“**d-m-Y**” day, month, year

- The Unit Weight display will show the current format, “**Y-m-d**” for example.
- Press the **[Tare]** key to accept the chosen format, the Count display will show the current settings. Enter the date in this format.
- Press the **[CE]** key to clear the current setting then enter the new values.
- Press the **[Tare]** key to accept the date.

An error code will be shown if the time (**Err 1**) or the date (**Err 2**) is not the permissible values. For example, 34th day of a month is an invalid entry.

Pressing the **[Zero]** key will escape for the date and time settings with the current values unchanged. It is possible to change only the time by setting a new time, then pressing the **[Zero]** key when the date settings are shown.

10.2 AUTO SLEEP FUNCTION

This function may be enabled or disabled by the user. If enabled, when the scale is not used for some time (as pre-set by the user under this function) it automatically switches off. To set this parameter-

- During self-checking, press **[Zero]** and release at once. The display shows **"SLEEP mode"**.
- Press **[U. Wt./Units]** key to scroll through the auto sleep values.
 - "0"** Auto sleep mode disabled
 - "1"** Auto sleep after 1 minute
 - "5"** Auto sleep after 5 minutes
 - "10"** Auto sleep after 10 minutes
- Press **[Tare]** to set the value. The scale returns to zero.

10.3 BACKLIGHT FOR LCD

- The backlight of the LCD can be set to be:
 1. ON at all the time,
 2. ON only when a weight is placed on the scale or
 3. Turned off.
- To set the backlight press and hold **[Pst]** key for 4 seconds.
- The weight display will show **"EL xx"** where **xx** is the current setting for the backlight.
- Press **[U. Wt./Units]** to scroll through the options.

"EL on"	Sets the backlight to be on at all times.
"EL Au"	Sets the backlight to operate automatically when a weight is placed on the scale or a key is pressed.
"EL OFF"	Sets the backlight to be off.

- Press the **[Tare]** key to store the value or press the **[Zero]** key to escape from this setting and return to weighing.

10.4 BATTERY

- The scales can be operated from the battery, if desired. The battery life is approximately 90 hours.
- When the battery needs charging the arrow above the low battery symbol under the “**Weight**” display will turn on. The battery should be charged as soon as the arrow is on. The scale will still operate for about 10 minutes after which it will automatically switch off to protect the battery.
- To charge the battery, simply plug the scale into the mains and switch the mains power ON. The scale does not need to be turned on.
- The battery should be charged for at least 12 hours for full capacity.
- Just under the “**Count**” display is an LED to indicate the status of battery charging. When the scale is plugged into the mains power, the internal battery will be charged. If the LED is green the battery is fully charged. If it is red, the battery is nearly discharged and yellow indicates the battery should be charged longer, preferably overnight.
- If the battery has not been used properly or it is used for a number of years it may eventually fail to hold a full charge. If the battery life becomes unacceptable then contact your supplier.

11.0 ERROR CODES

During the initial power-on testing or during operation, the scale may show an error message. The meaning of the error messages is described below.

If an error message is shown, repeat the step that caused the message, turning the balance on, carry out the calibration or other functions. If the error message is still shown contact your dealer for further support.

ERROR CODE	DESCRIPTION	POSSIBLE CAUSES
Err 1	Time input error.	Tried to set an illegal time, i.e. 26hours
Err 2	Date input error	Tried to set an illegal date, i.e. 36 th day
Err 4	Initial Zero is greater than allowed (typically 4% of the maximum capacity) when power is turned on or when the [Zero] key is pressed,	Weight is on the pan when turning the scale on. Excessive weight on the pan when zeroing the scale. Improper calibration of the scale. Damaged load cell. Damaged Electronics.
Err 6	A/D count is not correct when turning the scale on.	Platform is not installed. Damaged Load cell. Damaged Electronics.

12.0 REPLACEMENT PARTS AND ACCESSORIES

If you need to order any spare parts and accessories, contact your supplier or Adam Equipment. A partial list of such items is as follows-

- Mains Power cord
- Replacement Battery
- Stainless Steel Pan
- In use cover
- Printer, etc.

13.0 SERVICE INFORMATION

This manual covers the details of operation. If you have a problem with the scale that is not directly addressed by this manual then contact your supplier for assistance. In order to provide further assistance, the supplier will need the following information which should be kept ready:

A. Details of your company

- Name of your company:
- Contact person's name:
- Contact telephone, e-mail, fax or any other methods:

B. Details of the unit purchased

(This part of information should always be available for any future correspondence. We suggest you to fill in this form as soon as the unit is received and keep a print-out in your record for ready reference.)

Model name of the scale:	CBC ____
Serial number of the unit:	
Software revision number (Displayed when power is first turned on):	
Date of Purchase:	
Name of the supplier and place:	

C. Brief description of the problem

Include any recent history of the unit. For example:

- Has it been working since it's delivered
- Has it been in contact with water
- Damaged from a fire
- Electrical Storms in the area
- Dropped on the floor, etc.

WARRANTY INFORMATION

Adam Equipment offers Limited Warranty (Parts and Labour) for the components failed due to defects in materials or workmanship. Warranty starts from the date of delivery.

During the warranty period, should any repairs be necessary, the purchaser must inform its supplier or Adam Equipment Company. The company or its authorised Technician reserves the right to repair or replace the components at any of its workshops depending on the severity of the problems. However, any freight involved in sending the faulty units or parts to the service centre should be borne by the purchaser.

The warranty will cease to operate if the equipment is not returned in the original packaging and with correct documentation for a claim to be processed. All claims are at the sole discretion of Adam Equipment.

This warranty does not cover equipment where defects or poor performance is due to misuse, accidental damage, exposure to radioactive or corrosive materials, negligence, faulty installation, unauthorised modifications or attempted repair or failure to observe the requirements and recommendations as given in this User Manual. Additionally rechargeable batteries (where supplied) are not covered under warranty.

Repairs carried out under the warranty does not extend the warranty period. Components removed during the warranty repairs become the company property.

The statutory right of the purchaser is not affected by this warranty. The terms of this warranty is governed by the UK law. For complete details on Warranty Information, see the terms and conditions of sale available on our web-site.

WEEE 2012/19/EU

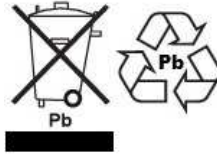

This device may not be disposed of in domestic waste. This also applies to countries outside the EU, per their specific requirements. Disposal of batteries (if fitted) must conform to local laws and restrictions.

Cet appareil ne peut être éliminé avec les déchets ménagers. L'élimination de la batterie doit être effectuée conformément aux lois et restrictions locales.

Dieses Gerät nicht mit dem Hausmüll entsorgt.

Dispositivo no puede ser desechado junto con los residuos domésticos

Dispositivo non può essere smaltito nei rifiuti domestici.

FCC / IC CLASS A DIGITAL DEVICE EMC VERIFICATION STATEMENT

NOTE: This equipment has been tested and found to comply with the limits for a Class A digital device, pursuant to Part 15 of the FCC rules and Canadian ICES-003/NMB-003 regulation. These limits are designed to provide reasonable protection against harmful interference when the equipment is operated in a commercial environment. This equipment generates, uses and can radiate radio frequency energy and, if not installed and used in accordance with the instruction manual, may cause harmful interference to radio communications. Operation of this equipment in a residential area is likely to cause harmful interference in which case the user will be required to correct the interference at his own expense.

CALIFORNIA PROPOSITION 65 - MANDATORY STATEMENT

WARNING: This product includes a sealed lead-acid battery which contains chemicals known to the State of California to cause cancer and birth defects or other reproductive harm.



Adam Equipment products have been tested with, and are always supplied with mains power adaptors which meet all legal requirements for the intended country or region of operation, including electrical safety, interference and energy efficiency. As we often update adaptor products to meet changing legislation it is not possible to refer to the exact model in this manual. Please contact us if you need specifications or safety information for your particular item. Do not attempt to connect or use an adaptor not supplied by us.

ADAM EQUIPMENT is an ISO 9001:2008 certified global company with more than 40 years' experience in the production and sale of electronic weighing equipment.

Adam products are predominantly designed for the Laboratory, Educational, Health and Fitness, Retail and Industrial Segments. The product range can be described as follows:

- Analytical and Precision Laboratory Balances
- Compact and Portable Balances
- High Capacity Balances
- Moisture analysers / balances
- Mechanical Scales
- Counting Scales
- Digital Weighing/Check-weighing Scales
- High performance Platform Scales
- Crane scales
- Mechanical and Digital Electronic Health and Fitness Scales
- Retail Scales for Price computing

For a complete listing of all Adam products visit our website at

www.adamequipment.com

<p>Adam Equipment Co. Ltd. Maidstone Road, Kingston Milton Keynes MK10 0BD UK Phone:+44 (0)1908 274545 Fax: +44 (0)1908 641339 e-mail: sales@adamequipment.co.uk</p>	<p>Adam Equipment Inc. 1, Fox Hollow Rd., Oxford, CT 06478 USA Phone: +1 203 790 4774 Fax: +1 203 792 3406 e-mail: sales@adamequipment.com</p>	<p>AE Adam GmbH. Instenkamp 4 D-24242 Felde Germany Phone +49 (0)4340 40300 0 Fax: +49 (0)4340 40300 20 e-mail: vertrieb@aeadam.de</p>
<p>Adam Equipment S.A. (Pty) Ltd. 7 Megawatt Road, Spartan EXT 22 Kempton Park, Johannesburg, Republic of South Africa Phone +27 (0)11 974 9745 Fax: +27 (0)11 392 2587 e-mail: sales@adamequipment.co.za</p>	<p>Adam Equipment (S.E. ASIA) PTY Ltd 2/71 Tacoma Circuit CANNING VALE 6155 Perth Western Australia Phone: +61 (0) 8 6461 6236 Fax +61 (0) 8 9456 4462 e-mail: sales@adamequipment.com.au</p>	<p>Adam Equipment (Wuhan) Co. Ltd. A Building East Jianhua Private Industrial Park Zhuanyang Avenue Wuhan Economic & Technological Development Zone 430056 Wuhan P.R.China Phone: + 86 (27) 59420391 Fax + 86 (27) 59420388 e-mail: info@adamequipment.com.cn</p>

© Copyright by Adam Equipment Co. All rights reserved. No part of this publication may be reprinted or translated in any form or by any means without the prior permission of Adam Equipment.

Adam Equipment reserves the right to make changes to the technology, features, specifications and design of the equipment without notice.

All information contained within this publication is to the best of our knowledge timely, complete and accurate when issued. However, we are not responsible for misinterpretations which may result from the reading of this material.

The latest version of this publication can be found on our Website.

www.adamequipment.com